



SPEEDMASTER[®]

SM2 Series Flux Vector
SM4 Series Flux Vector

Installation and
Operation Manual



A Regal Brand

REGAL

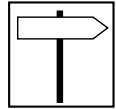

1	Safety information	3
2	Technical data	5
2.1	Standards and application conditions.....	5
2.2	Ratings.....	6
3	Installation.....	8
3.1	Dimensions and mounting	8
3.1.1	NEMA 1 (IP31) Models	8
3.1.3	NEMA 4X (IP65) Models	9
3.2	Electrical installation.....	10
3.2.1	Power Connections.....	10
3.2.1.1	Mains Connection to 120VAC Single-Phase Supply.....	10
3.2.1.2	Mains Connection to 240VAC Single-Phase Supply.....	11
3.2.1.3	Mains Connection to Three-Phase Supply.....	11
3.2.1.4	Motor Connection.....	11
3.2.1.5	Installation Recommendations for EMC Compliance	12
3.2.1.6	NEMA 4X (IP65) Input Terminal Block.....	12
3.2.1.7	Dynamic Brake Connections.....	13
3.2.2	Fuses/cable cross-sections.....	14
3.2.3	Control terminals.....	15
4	Commissioning.....	16
4.1	Local Keypad & Display	16
4.2	Drive Displays and Modes of Operation.....	19
4.3	Parameter setting	20
4.4	Electronic programming module (EPM)	20
4.5	Parameter menu.....	21
4.5.1	Basic Setup Parameters.....	21
4.5.2	I/O Setup Parameters.....	25
4.5.3	Advanced Setup Parameters	32
4.5.4	PID Parameters.....	37
4.5.5	Vector Parameters	40
4.5.6	Network Parameters.....	43
4.5.7	Diagnostic Parameters.....	44
4.5.7.1	Terminal & Protection Status Display	46
4.5.7.2	Keypad Status Display.....	46
4.5.8	Onboard Communications Parameters 15-25 HP	47
4.5.9	Sequencer Parameters	48
4.5.9.1	Sequencer Flow Diagram Left	57
4.5.9.2	Sequencer Flow Diagram Right	58
4.5.9.3	Sequencer Status.....	59
5	Troubleshooting and Diagnostics	60
5.1	Status/Warning Messages	60
5.2	Drive Configuration Messages	62
5.3	Fault Messages	6
Appendix A	66
A.1	Permissible Cable Lengths.....	66



About these instructions

This documentation applies to the SM2 and SM4 Vector frequency inverter, and contains important technical data and describes installation, operation, and commissioning.

These instructions are only valid for SM2 and SM4 Vector frequency inverters with software rev 20 (see drive nameplate).

Please read the instructions before commissioning.

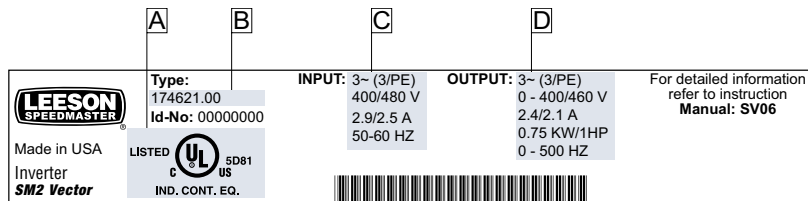

V0115

A Certifications

C Input Ratings

B Type

D Output Ratings

Scope of delivery	Important
<ul style="list-style-type: none"> • 1 SM2 or SM4 Vector inverter with EPM installed (see Section 4.4) • 1 Operating Instructions 	<p>After receipt of the delivery, check immediately whether the items delivered match the accompanying papers. LEESON does not accept any liability for deficiencies claimed subsequently.</p> <p>Claim</p> <ul style="list-style-type: none"> • visible transport damage immediately to the forwarder. • visible deficiencies / incompleteness immediately to your LEESON representative.

Safety information



All safety information given in these Operating Instructions have the same layout:



Signal Word! (characterizes the severity of the danger)

Note (describes the danger and informs on how to proceed)

Icon		Signal Words	
	Warning of hazardous electrical voltage	DANGER!	Warns of imminent / impending danger. Consequences if disregarded: will result in Death or severe injuries.
	Warning of a general danger	WARNING!	Warns of potential, very hazardous situations. Consequences if disregarded: could result in Death or serious injuries.
	Warning of damage to equipment	STOP!	Warns of potential damage to material and equipment. Consequences if disregarded: Damage to the controller/drive or its environment.
	Information	Note	Designates a general, useful note. If you observe it, handling the controller/drive system is made easier.

Note for UL approved system with integrated controllers: UL warnings are notes which apply to UL systems. The documentation contains special information about UL.



Warnings!

- Suitable for use on a circuit capable of delivering not more than 200,000 rms symmetrical amperes, at the maximum voltage rating marked on the drive.
- Use minimum 75 °C copper wire only.
- Shall be installed in a pollution degree 2 macro-environment.

Operation

Systems including controllers must be equipped with additional monitoring and protection devices according to the corresponding standards (e.g., technical equipment, regulations for prevention of accidents, etc.). The controller may be adapted to your application as described in this documentation.



DANGER!

- After the controller has been disconnected from the supply voltage, live components and power connection must not be touched immediately, since capacitors could be charged. Please observe the corresponding notes on the controller.
- Please close all protective covers and doors prior to and during operation.
- Do not cycle input power to the controller more than once every two minutes.



Safety information

1 Safety information

General



DANGER!

Some parts of LEESON controllers can be electrically live and some surfaces can be hot.

Non-authorized removal of the required cover, inappropriate use, and incorrect installation or operation creates the risk of serious injury to personnel or damage to equipment.

All operations concerning transport, installation, and commissioning as well as maintenance must be carried out by qualified, skilled personnel who are familiar with the installation, assembly, commissioning, and operation of variable frequency drives and the application for which it is being used.

Installation

Ensure proper handling and avoid excessive mechanical stress. Do not bend any components and do not change any insulation distances during transport, handling, installation or maintenance.

Do not touch any electronic components or contacts. This drive contains electrostatically sensitive components, which can easily be damaged by inappropriate handling. Static control precautions must be adhered to during installation, testing, service and repair of this drive and associated options. Component damage may result if proper procedures are not followed.

This drive has been tested by Underwriters Laboratory (UL) and is an approved component in compliance with UL508 Safety Standard.

This drive must be installed and configured in accordance with both national and international standards. Local codes and regulations take precedence over recommendations provided in this and other LEESON documentation.

The SM2 and SM4 Vector drive is considered a component for integration into a machine or process. It is neither a machine nor a device ready for use in accordance with European directives (reference machinery directive and electromagnetic compatibility directive). It is the responsibility of the end user to ensure that the machine meets the applicable standards.

Electrical connection



WARNING!

When working on live drive controllers, applicable national safety regulations must be observed.

The electrical installation must be carried out according to the appropriate regulations (e.g. cable cross-sections, fuses, protective earth [PE] connection). While this document makes recommendations in regard to these items, national and local codes must be adhered to.

The documentation contains information about installation in compliance with EMC (shielding, grounding, filters and cables). These notes must also be observed for CE-marked controllers.

The manufacturer of the system or machine is responsible for compliance with the required limit values demanded by EMC legislation.

Application



WARNING!

The drive must not be used as a safety device for machines where there is a risk of personal injury or material damage. Emergency Stops, over-speed protection, acceleration and deceleration limits, etc. must be made by other devices to ensure operation under all conditions.

The drive features many protection devices which are aimed at protecting the drive and the driven equipment by generating a fault and shutting the drive and motor down by removing power. Mains power variances can also result in shutdown of the drive. When the fault condition disappears or is cleared, the drive can be configured to automatically restart. It is the responsibility of the user and/or OEM and/or integrator to ensure that the drive is configured for safe operation.



2 Technical data

2.1 Standards and application conditions

Conformity	CE Low Voltage Directive (73/23/EEC)	
Approvals	UL 508C Underwriters Laboratories - Power Conversion Equipment	
Input voltage phase imbalance	≤ 2%	
Supported Power Systems	TT	<ul style="list-style-type: none"> - For central grounded systems, operation is permitted without restrictions. - For corner grounded 400/500V systems, operation is possible but reinforced insulation to control circuits is compromised.
	TN	
Humidity	≤ 95% non-condensing	
Temperature range	Transport	-25 ... +70°C
	Storage	-20 ... +70°C
	Operation	-10 ... +55°C (with 2.5%/°C current derating above +40°C)
Installation height	0 ... 4000m a.m.s.l. (with 5%/1000 m current derating above 1000m a.m.s.l.)	
Vibration resistance	acceleration resistant up to 1.0g	
 WARNING! Earth leakage current	> 3.5 mA to PE	
Max Permissible Cable Length ⁽¹⁾	≤4.0 Hp (3.0 kW)	30 meters shielded, 60 meters un-shielded
	⇒ 5.0 Hp (3.7 kW)	50 meters shielded, 100 meters un-shielded
Enclosure	IP31 / NEMA 1	IP65/NEMA 4X
	NEMA 1 and NEMA 4X model enclosures are plenum rated in accordance with UL 508C and are suitable for installation in a compartment handling conditioned air.	
Protection measures against	short circuit, earth fault, phase loss, over voltage, under voltage, motor stalling, over temperature, motor overload	
Compliance with EN 61000-3-2 Requirements ⁽²⁾	< 0.5 kW	with mains choke
	0.5 ... 1 kW	with active filter
	> 1 kW	without additional measures
Compliance with EN 61000-3-12 Requirements ⁽²⁾	16 ... 75 amp	Additional measures required for compliance with EN 61000-3-12

Operation in public supply networks (Limitation of harmonic currents i.a.w. EN 61000-3-2, Electromagnetic Compatibility (EMC) Limits). Limits for harmonic current emissions (equipment input current up to 16A/phase).

(1) The stated cable lengths are permissible at default carrier frequencies (refer to parameter P166).

(2) The additional measures described only ensure that the controller meets the requirements of the EN 61000-3-2. The machine/system manufacturer is responsible for the machine's compliance with the regulations.



Technical data

2.2 Ratings

120VAC Doubler / 240VAC Models

Type	Power [Hp/kW]	Mains			Output Current		SM2 Watts Loss	SM4 Watts Loss
		Voltage ⁽¹⁾	I _{in} (120V)	I _{in} (240V)	I _n	CLim _{max} ⁽²⁾		
174603	0.33 / 0.25	120 V Single-phase (1/N/PE) (90 ... 132 V) OR 240 V Single-phase (2/PE) (170 ... 264 V)	6.8	3.4	1.7	200	24	
174604-174652	0.5 / 0.37		9.2	4.6	2.4	200	32	32
174605-174653	1 / 0.75		16.6	8.3	4.2	200	52	41
174651-174654	1.5 / 1.1		20.0	10.0	6.0	200	74	74

240VAC Models

Type	Power [Hp/kW]	Mains			Output Current		SM2 Watts Loss	SM4 Watts Loss
		Voltage ⁽¹⁾	I _{in} 1- (2/PE)	I _{in} 3- (3/PE)	I _n	CLim _{max} ⁽²⁾		
174606	0.33 / 0.25	240 V Single Phase (2/PE)	3.4	-	1.7	200	20	
174607-174655	0.5 / 0.37	240 V Single-phase (2/PE) OR 240 V Three-phase (3/PE) (170 ... 264 V)	5.1	2.9	2.4	200	27	30
174608-174656	1 / 0.75		8.8	5.0	4.2	200	41	42
174609-174657	1.5 / 1.1		12.0	6.9	6.0	200	64	63
174610-174658	2 / 1.5		13.3	8.1	7.0	200	75	73
174611-174659	3 / 2.2		17.1	10.8	9.6	200	103	97
174612	1.5 / 1.1		-	6.9	6.0	200	64	59
174613	2 / 1.5		-	8.1	7.0	200	75	69
174614	3 / 2.2	240 V Three-phase (3/PE) (170 V ... 264 V)	-	10.8	9.6	200	103	93
174615-174660	5 / 4.0		-	18.6	16.5	200	154	139
174616-174661	7.5 / 5.5		-	26	23	200	225	167
174617-174662	10 / 7.5		-	33	29	200	274	242
174618	15 / 11		-	48	42	180	485	468
174619	20 / 15		-	59	54	180	614	591

(1) Frequency Range: 48 Hz ... 62 Hz

(2) Current Limit (CLim) is a percentage of the output current, I_n. CLim_{max} is the maximum setting for P171.



480VAC Models

Type	Power [Hp/kW]	Mains				Output Current				SM2 Watts Loss	SM4 Watts Loss
		Voltage ⁽¹⁾	I _{in}		I _n		CLim _{max} ⁽²⁾				
			400V	480V	400V	480V	400V	480V			
174620-174671	0.5 / 0.37	400 V Three-phase (3/PE) (340 ... 440 V) OR 480 V Three-phase (3/PE) (340 ... 528 V)	1.7	1.5	1.3	1.1	175	200	23	21	
174621-174672	1 / 0.75		2.9	2.5	2.4	2.1	175	200	37	33	
174622-174673	1.5 / 1.1		4.2	3.6	3.5	3.0	175	200	48	42	
174623-174674	2 / 1.5		4.7	4.1	4.0	3.5	175	200	57	50	
174624-174675	3 / 2.2		6.1	5.4	5.5	4.8	175	200	87	78	
174625-174676	5 / 4.0		10.6	9.3	9.4	8.2	175	200	128	103	
174626-174677	7.5 / 5.5		14.2	12.4	12.6	11.0	175	200	178	157	
174627-174678	10 / 7.5		18.1	15.8	16.1	14.0	175	200	208	190	
174628	15 / 11		27	24	24	21	155	180	418		
174629	20 / 15		35	31	31	27	155	180	493		
174630	25 / 18.5		44	38	39	34	155	180	645		
174991	30 / 22		52	45	46	40	155	180	709		
174992	40 / 30		68	59	60	52	155	180	1020		
174710	50 / 37.5		85	74	75	65	155	180	1275		
174711	60 / 45		100	87	88	77	155	180	1530		

600 VAC Models

Type	Power [Hp/kW]	Mains				Output Current				SM2 Watts Loss	SM4 Watts Loss
		Voltage ⁽¹⁾	I _{in}		I _n		CLim _{max} ⁽²⁾				
			400V	480V	400V	480V	400V	480V			
174631-174663	1 / 0.75	600 V Three-phase (3/PE) (425 ... 660 V)	2.0		1.7		200		37	31	
174632-174664	2 / 1.5		3.2		2.7		200		51	43	
174633-174665	3 / 2.2		4.4		3.9		200		68	57	
174634-174666	5 / 4.0		6.8		6.1		200		101	67	
174635-174667	7.5 / 5.5		10.2		9		200		148	116	
174636-174668	10 / 7.5		12.4		11		200		172	152	
174637	15 / 11		19.7		17		180		380		
174638	20 / 15		25		22		180		463		
174639	25 / 18.5		31		27		180		560		
174993	30 / 22		36		32		180		640		
174994	40 / 30		47		41		180		930		
174712	50 / 37.5		59		52		180		1163		
174713	60 / 45		71		62		180		1395		

(1) Frequency Range: 48 Hz ... 62 Hz

(2) Current Limit (CLim) is a percentage of the output current, I_n. CLim_{max} is the maximum setting for P171.

For 480VAC models, the CLim_{max} value in the 480V column of the table is used when P107 is set to 1.

The CLim_{max} value in the 400V column is used when P107 is set to 0.



STOP!

Drive Derating

The SM2 and SM4 Vector Series drive is designed to operate at the Nominal Output Current (I_n) shown in the Ratings tables for most standard applications and industrial environments. The drive output current or operating temperature may need to be limited as described below:

- For installations above 1000m a.m.s.l., derate I_n by 5% per 1000m, do not exceed 4000m a.m.s.l.
- Operation above 40°C, derate I_n by 2.5% per °C, do not exceed 55°C.
- Carrier Frequency (P166):
 - If P166=2 (8 kHz), derate I_n to 92% of drive rating or do not exceed 33°C ambient
 - If P166=3 (10 kHz), derate I_n to 84% of drive rating or do not exceed 27°C ambient

For combinations of the above, please consult LEESON applications support for proper derating.

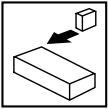

Installation

3 Installation

3.1 Dimensions and mounting

3.1.1 NEMA 1 (IP31)

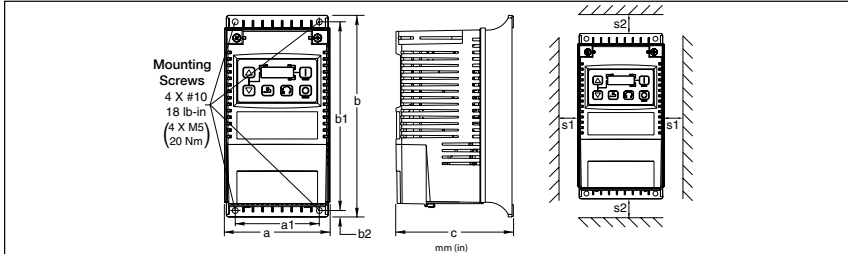

V0102

	Type	a in (mm)	a1 in (mm)	b in (mm)	b1 in (mm)	b2 in (mm)	c in (mm)	s1 in (mm)	s2 in (mm)	m lb (kg)
CH1	174603 - 174608, 174620 - 174621, 174631	3.90 (99)	3.10 (79)	7.50 (190)	7.00 (178)	0.25 (6)	4.35 (110)	0.6 (15)	2.0 (50)	2.0 (0.9)
CH2	174609 - 174614, 174622 - 174624, 174632 - 174633 174651	3.90 (99)	3.10 (79)	7.50 (190)	7.00 (178)	0.25 (6)	5.45 (138)	0.6 (15)	2.0 (50)	2.8 (1.3)
CH3	174615, 174625, 174634	3.90 (99)	3.10 (79)	7.50 (190)	7.00 (178)	0.25 (6)	5.80 (147)	0.6 (15)	2.0 (50)	3.2 (1.5)
CH4	174616 - 174617, 174626 - 174627, 174635 - 174636	5.12 (130)	4.25 (108)	9.83 (250)	9.30 (236)	0.25 (6)	6.25 (159)	0.6 (15)	2.0 (50)	6.0 (2.0)
CH5	174618 - 174619, 174628 - 174630, 174637 - 174639 174991, 174993	6.92 (176)	5.75 (146)	12.50 (318)	11.88 (302)	0.31 (8)	8.09 (205)	0.6 (15)	2.0 (50)	13.55 (6.15)

Conduit Hole Dimensions	Type	Conduit Hole Dimensions				
		N in (mm)	P in (mm)	P1 in (mm)	Q in (mm)	S in (mm)
	CH1	1.84 (47)	1.93 (49)	.70 (18)	1.00 (25)	.88 (22)
	CH2	1.84 (47)	3.03 (77)	.70 (18)	1.00 (25)	.88 (22)
	CH3	1.84 (47)	3.38 (86)	.70 (18)	1.00 (25)	.88 (22)
	CH4	2.46 (62)	3.55 (90)	.13 (3)	1.38 (35)	.88 (22)
	CH5	3.32 (84)	4.62 (117)	.73 (19)	1.40 (36)	.88 (22)

WARNING!

Drives must not be installed where subjected to adverse environmental conditions such as: combustible, oily, or hazardous vapors or dust; excessive moisture; excessive vibration or excessive temperatures. Contact LEESON for more information.



Installation

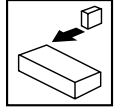

3.1.1 NEMA 1 (IP31) Models > 30HP (22kW)

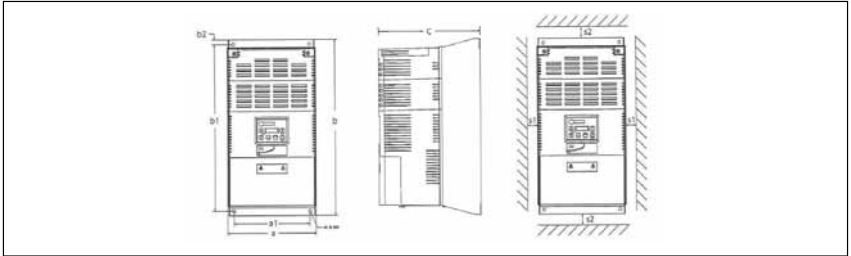

V0102

	Type	a in (mm)	a1 in (mm)	b in (mm)	b1 in (mm)	b2 in (mm)	c in (mm)	s1 in (mm)	s2 in (mm)	m lb (kg)
CH6	174992 174994	8.72 (221)	7.50 (190)	14.19 (360)	13.30 (338)	0.45 (11.4)	10.07 (256)	0.6 (15)	2.0 (50)	24.0 (10.9)
CH7	174710 174712	8.72 (221)	7.50 (190)	17.19 (436)	16.30 (414)	0.45 (11.4)	10.07 (256)	0.6 (15)	2.0 (50)	31 (14.1)
CH8	174711 174713	8.72 (221)	7.50 (190)	20.09 (513)	19.30 (490)	0.45 (11.4)	10.07 (256)	0.6 (15)	2.0 (50)	35 (15.9)

Conduit Hole Dimensions	Type	N in (mm)	P in (mm)	P1 in (mm)	Q in (mm)	S in (mm)	S1 in (mm)
	CH6	3.75 (95)	5.42 (137)	1.50 (38.1)	1.75 (44.4)	1.75 (44.4)	0.875 (22.2)
	CH7	3.75 (95)	5.42 (137)	1.50 (38.1)	1.75 (44.4)	1.75 (44.4)	0.875 (22.2)
	CH8	3.75 (95)	5.42 (137)	1.50 (38.1)	1.75 (44.4)	1.75 (44.4)	0.875 (22.2)



WARNING!

Drives must not be installed where subjected to adverse environmental conditions such as: combustible, oily, or hazardous vapors or dust; excessive moisture; excessive vibration or excessive temperatures. Contact LEESON for more information.

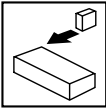

Installation

3.1.3 NEMA 4 (IP65)

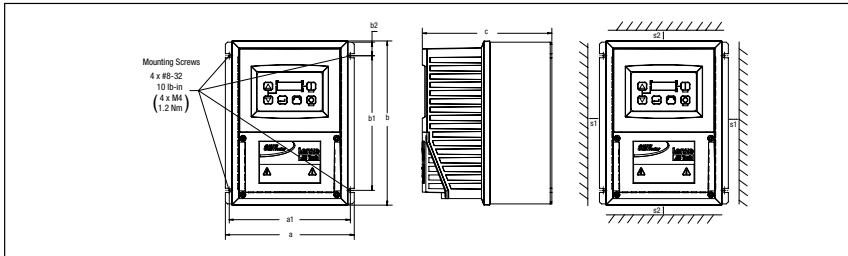

V0102

	Type	a in (mm)	a1 in (mm)	b in (mm)	b1 in (mm)	b2 in (mm)	c in (mm)	s1 in (mm)	s2 in (mm)	m lb (kg)
CH1	174652 - 174656, 174671 - 174672, 174663	6.28 (160)	5.90 (150)	8.00 (203)	6.56 (167)	0.66 (17)	4.47 (114)	2.00 (51)	2.00 (51)	3.6 (1.63)
CH2	174657 - 174658, 174673 - 174675, 174664 - 174665	6.28 (160)	5.90 (150)	8.00 (203)	6.56 (167)	0.66 (17)	6.31 (160)	2.00 (51)	2.00 (51)	5.9 (2.68)
CH3	174659	7.12 (181)	6.74 (171)	8.00 (203)	6.56 (167)	0.66 (17)	6.77 (172)	2.00 (51)	2.00 (51)	7.1 (3.24)
CH4	174661 - 174662, 174678 174668	8.04 (204)	7.56 (192)	10.00 (254)	8.04 (204)	0.92 (23)	8.00 (203)	4.00 (102)	4.00 (102)	10.98 (4.98)
CH5	174660 174676-174677 174666-174667	8.96 (228)	8.48 (215)	10.00 (254)	8.04 (204)	0.92 (23)	8.00 (203)	4.00 (102)	4.00 (102)	11.58 (5.25)

Conduit Hole Dimensions		Type	N in (mm)	P in (mm)	Q in (mm)	S in (mm)	S1 in (mm)
		CH1	3.14 (80)	2.33 (59)	1.50 (38)	.88 (22)	n/a
		CH2	3.14 (80)	4.18 (106)	1.50 (38)	.88 (22)	n/a
		CH3	3.56 (90)	4.63 (118)	1.50 (38)	.88 (22)	n/a
		CH4	4.02 (102)	5.00 (127)	1.85 (47)	1.06 (27)	n/a
		CH5	4.48 (114)	5.00 (127)	1.85 (47)	1.06 (27)	n/a



WARNING!

Drives must not be installed where subjected to adverse environmental conditions such as: combustible, oily, or hazardous vapors or dust; excessive moisture; excessive vibration or excessive temperatures. Contact LEESON for more information.

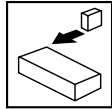

3.2 Electrical installation

Installation After a Long Period of Storage



STOP!

Severe damage to the drive can result if it is operated after a long period of storage or inactivity without reforming the DC bus capacitors.

If input power has not been applied to the drive for a period of time exceeding three years (due to storage, etc.), the electrolytic DC bus capacitors within the drive can change internally, resulting in excessive leakage current. This can result in premature failure of the capacitors if the drive is operated after such a long period of inactivity or storage.

In order to reform the capacitors and prepare the drive for operation after a long period of inactivity, apply input power to the drive for 8 hours prior to actually operating the motor.

3.2.1 Power Connections



DANGER!

Hazard of electrical shock! Circuit potentials are up to 600 VAC above earth ground. Capacitors retain charge after power is removed. Disconnect power and wait at least three minutes before servicing the drive.



STOP!

- Verify mains voltage before connecting to drive.
- Do not connect mains power to the output terminals (U,V,W)! Severe damage to the drive will result.
- Do not cycle mains power more than once every two minutes. Damage to the drive will result.



Mains and Motor Terminations		
Type	Torque	Strip Length
174991, 174992	24 lb-in (2.7 Nm)	7/16 in (10mm)
174710, 174711	27 lb-in (3.05 Nm)	0.75 in (19mm)

3.2.1.1 Mains connection to 120VAC Single-Phase Supply

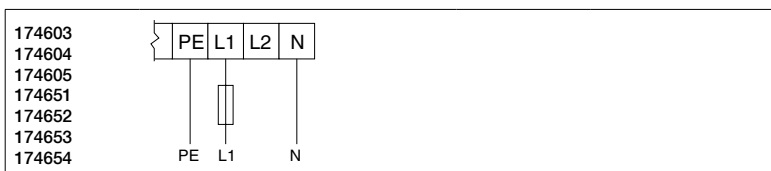

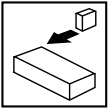

Installation

3.2.1.2 Mains connection to 240VAC Single-Phase Supply

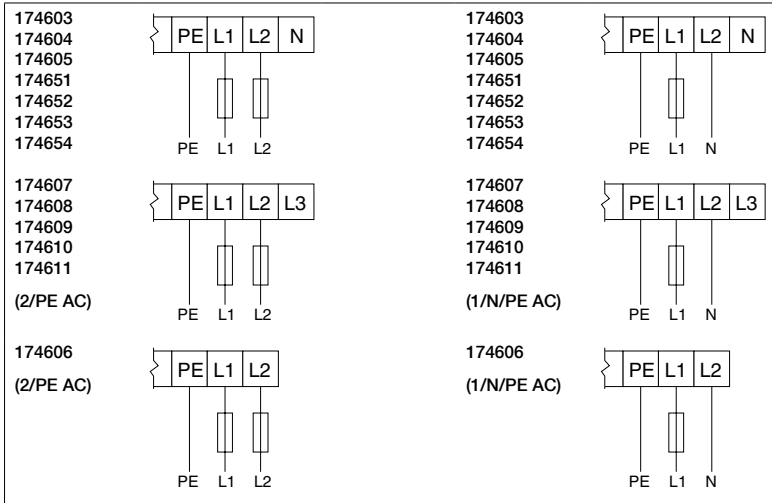

3.2.1.3 Mains connection to Three-Phase Supply

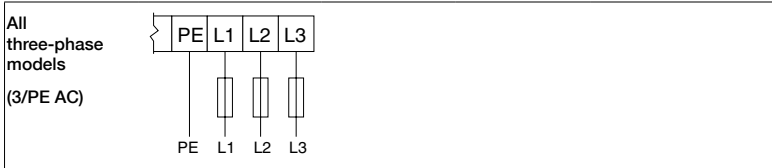

3.2.1.4 Motor Connection

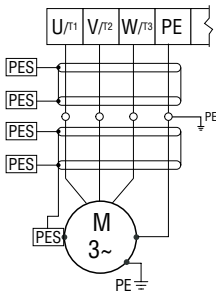

[PES] = Protective Earth Shielding

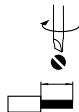

Mains and Motor Terminations

12 lb-in (1.3 Nm)

0.25 in (6mm)

SM4 Cover Screws Torque 6-7 lb-in

WARNING!

Leakage current may exceed 3.5 mA AC. Minimum size of the protective earth conductor shall comply with local safety regulations for high leakage current equipment.



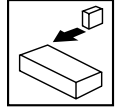

3.2.1.5 Installation Recommendations for EMC Compliance

For compliance with EN 61800-3 or other EMC standards, motor cables, line cables and control or communications cables must be shielded with each shield/screen clamped to the drive chassis. This clamp is typically located at the conduit mounting plate.

Motor cable should be low capacitance (core/core <75pF/m, core/shield <150pF/m). Filtered drives can meet the class A limits of EN 55011 and EN 61800-3 Category 2 with this type of motor cable up to 10 meters. **NOTE:** Refer to Appendix A for recommended cable lengths. Any external line filter should have its chassis connected to the drive chassis by mounting hardware or with the shortest possible wire or braid.

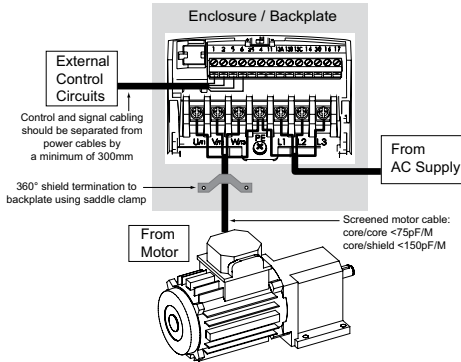

3.2.1.6 NEMA 4X (IP65) Input Terminal Block

For NEMA 4X (IP65) models with integrated EMC filter and/or integrated line disconnect, the input terminal block is located on the right-hand side of the SM4 inverter in the NEMA 4 X (IP65) enclosure. The single and three phase models are illustrated herein. Refer to paragraph 3.2.3 Control Terminals for pin out information.

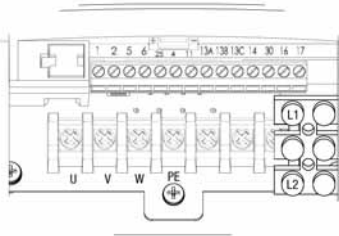

Single Phase (2/PE)

With Filter and/or integrated line disconnect

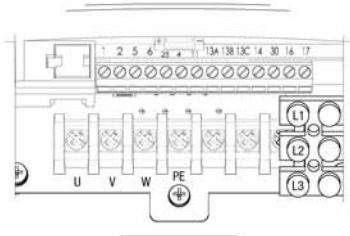

Three Phase (3/PE)

With Filter and/or integrated line disconnect



WARNING

Power remains present for up to 3 minutes on power input terminals (L1, L2 and L3) and output terminals (U, V and W) even when the disconnect switch is in the OFF position. Remove input power ahead of the drive and wait 3 minutes before removing the terminal cover.

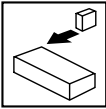

Installation

3.2.1.7 Dynamic Brake Connections

For NEMA 1 and NEMA 4X Drives rated up to 25 HP the Dynamic Brake connections are made as illustrated herein. Refer to the SM2 and SM4 Dynamic Brake instructions for complete information.

NEMA 1 (IP31) up to 30 HP

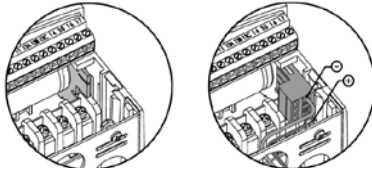

NEMA 4 (IP65) up to 10 HP

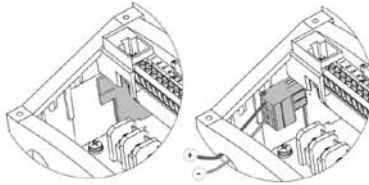

The 40...40HP (30...45kW) models include a dynamic brake transistor as standard and only require the connection of an external resistor kit for dynamic braking operation. The dynamic brake resistor connections for 40...60HP (30...45kW) drives are standard built-in connections as illustrated in the diagram below. In the 40HP (30kW) model drives, the dynamic brake connector is on the right-hand side of the drive and the terminals from top to bottom are B-, BRAKE and B+. In the 50/60HP (37.5/45kW) model drives, the dynamic brake connector is on the left-hand side of the drive and the terminals from top to bottom are B+, BRAKE and B-.

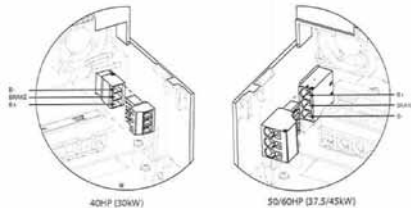

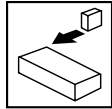

3.2.2 Fuses/cable cross-sections



Note

Observe local regulations.
Local codes may supersede these recommendations

Type		Recommendations				
		Fuse	Miniature circuit breaker ⁽¹⁾	Fuse ⁽²⁾ or Breaker ⁽³⁾ (N. America)	Input Power Wiring (L1, L2, L3, PE)	
					[mm ²]	[AWG]
120V 1- (1/N/PE)	174603	M10 A	C10 A	10 A	1.5	14
	174604, 174652.00	M16 A	C16 A	15 A	2.5	14
	174605, 174653.00	M25 A	C25 A	25 A	4	10
240V 1- (2/PE)	174603, 174604, 174652, 174653 174607, 174606	M10 A	C10 A	10 A	1.5	14
	174605, 174608	M16 A	C16 A	15 A	2.5	14
	174609, 174651, 174654, 174657	M20 A	C20 A	20 A	2.5	12
	174610, 174658	M25 A	C25 A	25 A	2.5	12
	174611, 174659	M32 A	C32A	32 A	4	10
240V 3- (3/PE)	174607, 174608, 174606	M10 A	C10 A	10 A	1.5	14
	174609, 174610, 174612, 174613	M16 A	C16 A	12 A	1.5	14
	174651, 174654, 174657, 174658					
	174611, 174614, 174659	M20 A	C20 A	20 A	2.5	12
	174615, 174660	M32 A	C32 A	32 A	4.0	10
	174616, 174661	M40 A	C40 A	35 A	6.0	8
	174617, 174662	M50 A	C50 A	45 A	10	8
	174618	M80 A	C80 A	80 A	16	8
	174619	M100A	C100A	90 A	16	8
400V or 480V 3- (3/ PE)	174620, 174624, 174671, 174675	M10 A	C10 A	10 A	1.5	14
	174625, 174676	M16 A	C16 A	20 A	2.5	14
	174626, 174677	M20 A	C20 A	20 A	2.5	14
	174627, 174678	M25 A	C25 A	25 A	4.0	10
	174628	M40 A	C40 A	40 A	4	8
	174629	M50 A	C50 A	50 A	10	8
	174630	M63 A	C63 A	70 A	10	6
	174991	M80 A	C80 A	80 A	16	6
	174992	M100 A	C100 A	100 A	25	4
	174710	M125 A	C125 A	125 A	35	2
	174711	M180 A	C160 A	150 A	35	1
600V 3- (3/ PE)	174631, 174632, 174633, 174663, 174665	M10 A	C10 A	10 A	1.5	14
	174634, 174666	M16 A	C16 A	12 A	1.5	14
	174635, 174667	M16 A	C16 A	15 A	2.5	14
	174636, 174668	M20 A	C20 A	20 A	2.5	12
	174637	M32 A	C32 A	30 A	4	10
	174638	M40 A	C40 A	40 A	4	8
	174639	M50 A	C50 A	50 A	6	8
	174993	M63 A	C63 A	60 A	10	8
	174994	M80 A	C80 A	70 A	16	6
	174712	M100 A	C100 A	90 A	16	4
	174713	M125 A	C125 A	110 A	25	2

(1) Installations with high fault current due to large supply mains may require a type D circuit breaker.

(2) UL Class CC or T fast-acting current-limiting type fuses, 200,000 AIC, preferred. Bussman KTK-R, JJJ or JJS or equivalent.

(3) Thermomagnetic type breakers preferred.

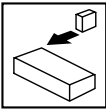

Installation

Observe the following when using Ground Fault Circuit Interrupters (GFCIs):

- Installation of GFCI only between supplying mains and controller.
- The GFCI can be activated by:
 - capacitive leakage currents between the cable screens during operation (especially with long, screened motor cables)
 - connecting several controllers to the mains at the same time
 - RFI filters

3.2.3 Control terminals

Control Terminal Strip for 0.33-10HP (0.25-7.5 kW):

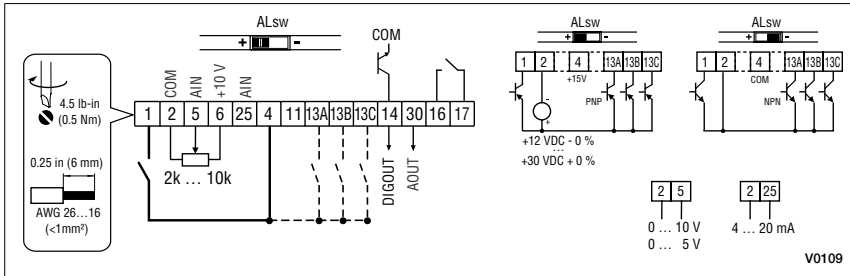

Terminal	Data for control connections	
1	Digital Input: Start/Stop	input resistance = 4.3kΩ
2	Analog Common	
5	Analog Input: 0...10 VDC	input resistance: >50 kΩ
6	Internal DC supply for speed pot	+10 VDC, max. 10 mA
25	Analog Input: 4...20 mA	input resistance: 250Ω
4	Digital Reference/Common	+15 VDC / 0 VDC, depending on assertion level
11	Internal DC supply for external devices	+12 VDC, max. 50 mA
13A	Digital Input: Configurable with P121	input resistance = 4.3kΩ
13B	Digital Input: Configurable with P122	
13C	Digital Input: Configurable with P123	
13D*	Digital Input: Configurable with P124	
14	Digital Output: Configurable with P142	DC 24 V / 50 mA; NPN
30	Analog Output: Configurable with P150...P155	0...10 VDC, max. 20 mA
16	Relay output: Configurable with P140	AC 250 V / 3 A
17		DC 24 V / 2 A ... 240 V / 0.22 A, non-inductive
2*	Analog Common	
TXA*	RS485 TXA	
TXB*	RS485 TXB	

* = Terminal is part of the terminal strip for the 15-25 HP models only



Control Terminal Strip for 15HP (11 kW) and Greater Drives:

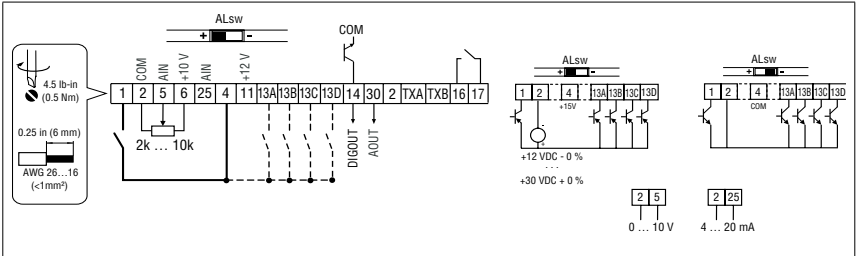

The digital inputs can be configured for active-high or active-low by setting the Assertion Level Switch (ALsw) and P120. If wiring to the drive inputs with dry contacts or with PNP solid state switches, set the switch and P120 to “High” (+). If using NPN devices for inputs, set both to “Low” (-). Active-high (+) is the default setting.

HIGH = +12 ... +30 V
LOW = 0 ... +3 V



Note

An *F.AL* fault will occur if the Assertion Level switch (ALsw) position does not match the parameter P120 setting and P100 or any of the digital inputs (P121...P123) is set to a value other than 0.

4 Commissioning

4.1 Local Keypad & Display

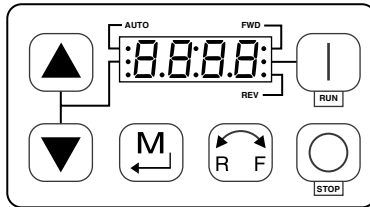





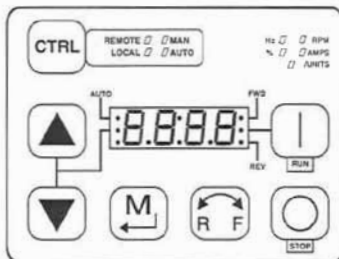

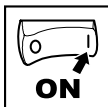



V0105

15HP (1kW) and greater Models





Commissioning

Display	START BUTTON
	In Local Mode (P100 = 0, 4, 6), this button will start the drive.
	STOP BUTTON
	Stops the drive, regardless of which mode the drive is in.
	WARNING! When JOG is active, the STOP button will not stop the drive!
	ROTATION
	In Local Mode (P100 = 0, 4, 6), this selects the motor rotation direction: <ul style="list-style-type: none"> - The LED for the present rotation direction (FWD or REV) will be on - Press R/F; the LED for the opposite rotation direction will blink - Press M within 4 seconds to confirm the change - The blinking direction LED will turn on, and the other LED will turn off <p>When rotation direction is changed while the drive is running, the commanded direction LED will blink until the drive is controlling the motor in the selected direction.</p>
	MODE
	Used to enter/exit the Parameter Menu when programming the drive and to enter a changed parameter value.
	UP AND DOWN BUTTONS
	Used for programming and can also be used as a reference for speed, PID setpoint, or torque setpoint.
	When the ▲ and ▼ buttons are the active reference, the middle LED on the left side of the display will be on.
Display	INDICATING LEDs (on 4-character display)
	FWD LED: Indicate the present rotation direction is forward. Refer to ROTATION description above.
	REV LED: Indicate the present rotation direction is reverse. Refer to ROTATION description above.
	AUTO LED: Indicates that the drive has been put into Auto mode from one of the TB13 inputs (P121... P124 set to 1...7). Also indicates that PID mode is active (if enabled).
	RUN LED: Indicates that the drive is running.
	▲ ▼ LED: Indicates that the ▲ ▼ are the active reference.

Commissioning

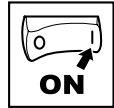

NOTE

If the keypad is selected as the auto reference (P121...P124 is 6) and the corresponding TB-13 input is closed, the AUTO LED and ▲ ▼ LEDs will both be on.

FUNCTIONS THAT FOLLOW ARE APPLICABLE TO SM2 DRIVES 15HP (11kW) AND GREATER

CTRL

CTRL

The CTRL pushbutton selects the start and speed reference control sources for the drive.

Press mode button to accept the new control mode selection.

CTRL LEDs		START CONTROL	REFERENCE CONTROL
	[LOCAL] [MAN]	Keypad	P101 Settings
	[LOCAL] [AUTO]	Keypad	Terminal 13x Settings
	[REMOTE] [MAN]	Terminal Strip	P101 Settings
	[REMOTE] [AUTO]	Terminal Strip	Terminal 13x Settings
If P100 = 6 the CTRL button is used to toggle start control between the terminal strip [REMOTE] and the keypad [LOCAL]		- REM/LOC LED indicating the present start control source is ON - Press [CTRL]; the LED for other start control source will blink - Press [M] within 4 sec to confirm the change - Blinking LED will turn ON (the other LED will turn OFF)	
If P113 = 1 the CTRL button is used to toggle reference control between the TB-13x setup [AUTO] and P101 [MANUAL]		- AUT/MAN LED indicating present reference control is ON - Press [CTRL]; the other reference control will blink - Press [M] within 4 sec to confirm change - Blinking LED will turn ON (the other LED will turn OFF)	
If P100 = 6 and P113 = 1, it is possible to change the start and reference control sources at the same time			



Commissioning

Display	START CONTROL						
	The REMOTE/LOCAL LEDs indicate the current start control source. If the start control source is a remote keypad or the network, then both LEDs will be OFF.						
	REFERENCE CONTROL						
	The AUTO/MANUAL LEDs indicate the current reference control source.						
	IF P113 = 0 or 2, the AUTO/MANUAL LEDs will match the AUTO LED on the 4-character display. IF P113 = 0 and no AUTO reference has been setup on the terminal strip, the MANUAL LED will turn ON and the AUTO LED will turn OFF.						
	IF P113 = 1, the AUTO/MANUAL LEDs show the commanded reference control source as selected by the [CTRL] button. If the [CTRL] button is used to set the reference control source to AUTO but no AUTO reference has been setup on the terminal strip, reference control will follow P101 but the AUTO LED will remain ON.						
	UNITS LEDS						
	<table border="1"> <tbody> <tr> <td>HZ: current display value is in Hz</td> <td rowspan="5"> In Speed mode, if P178 = 0 then HZ LED will be ON. If P178 > 0, the Units LEDs follow the setting of P177 when the drive is in run (non-programming) mode. In Torque mode, the HZ LED will be ON when the drive is in run (non-programming) mode. In Pid mode, the Units LEDs follow the setting of P203 when the drive is in run (non-programming) mode. If P179 > 0, the Units LEDs will show the unit of the diagnostic parameter that is being displayed. </td> </tr> <tr> <td>%: current display value is in %</td> </tr> <tr> <td>RPM: current display value is in RPM</td> </tr> <tr> <td>AMPS: current display value is in Amps</td> </tr> <tr> <td>/UNITS current display value is a per unit (i.e./sec, /min, /hr, etc.)</td> </tr> </tbody> </table>	HZ: current display value is in Hz	In Speed mode, if P178 = 0 then HZ LED will be ON. If P178 > 0, the Units LEDs follow the setting of P177 when the drive is in run (non-programming) mode. In Torque mode, the HZ LED will be ON when the drive is in run (non-programming) mode. In Pid mode, the Units LEDs follow the setting of P203 when the drive is in run (non-programming) mode. If P179 > 0, the Units LEDs will show the unit of the diagnostic parameter that is being displayed.	%: current display value is in %	RPM: current display value is in RPM	AMPS: current display value is in Amps	/UNITS current display value is a per unit (i.e./sec, /min, /hr, etc.)
HZ: current display value is in Hz	In Speed mode, if P178 = 0 then HZ LED will be ON. If P178 > 0, the Units LEDs follow the setting of P177 when the drive is in run (non-programming) mode. In Torque mode, the HZ LED will be ON when the drive is in run (non-programming) mode. In Pid mode, the Units LEDs follow the setting of P203 when the drive is in run (non-programming) mode. If P179 > 0, the Units LEDs will show the unit of the diagnostic parameter that is being displayed.						
%: current display value is in %							
RPM: current display value is in RPM							
AMPS: current display value is in Amps							
/UNITS current display value is a per unit (i.e./sec, /min, /hr, etc.)							

4.2 Drive Displays and Modes of Operation

Speed Mode Display

In the standard mode of operation, the drive frequency output is set directly by the selected reference (keypad, analog reference, etc.). In this mode, the drive display will show the drive's output frequency.

PID Mode Display

When the PID mode is enabled and active, the normal run display shows the actual PID setpoint. When PID mode is not active, the display returns to showing the drive's output frequency.

Torque Mode Display

When the drive is operating in Vector Torque mode, the normal run display shows the drive's output frequency.

Alternate (Run-Screen) Display

When P179 (Run Screen Display) is set to a value other than 0, one of the diagnostic parameters (P501...P599) is displayed. Example: if P179 is set to 1, then diagnostic parameter P501 (Software version) is displayed. If P179 = 2, then P502 (Drive ID) is displayed.

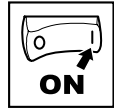

4.3 Parameter setting

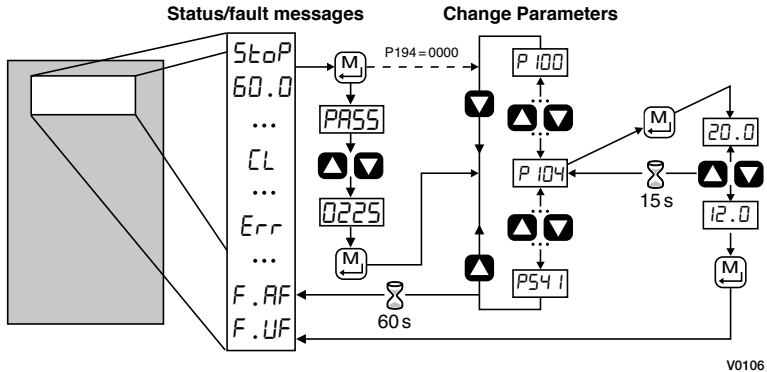

V0106

4.4 Electronic programming module (EPM)

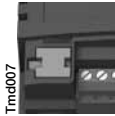

The EPM contains the drive's operational memory. Parameter settings are stored in the EPM and setting changes are made to the "User settings" in the EPM.

An optional EPM Programmer (model EEPM1RA) is available that allows:

- An EPM to be copied directly to another EPM.
- An EPM to be copied to the memory of the EPM Programmer.
- Stored files can be modified in the EPM Programmer.
- Stored files can be copied to another EPM.

As the EPM Programmer is battery operated, parameter settings can be copied to an EPM and inserted into a drive without power being applied to the drive. This means that the drive will be fully operational with the new settings on the next application of power.

Additionally, when the drive's parameter settings are burned into an EPM with the EPM Programmer, the settings are saved in two distinct locations: the "User settings" and the "OEM default settings". While the User settings can be modified in the drive, the OEM settings cannot. Thus, the drive can be reset not only to the "factory" drive default settings (shown in this manual), but can be set to the Original Machine settings as programmed by the OEM.

While the EPM can be removed for copying or to use in another drive, it must be installed for the drive to operate (a missing EPM will trigger an F.F I fault).

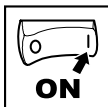

Commissioning



4.5 Parameter menu

4.5.1 Basic Setup Parameters

Code		Possible Settings		IMPORTANT
No.	Name	Default	Selection	
P100	Start Control Source	0	0 Local Keypad	Use RUN button on front of drive to start
			1 Terminal Strip	Use start/stop circuit wired into the terminal strip. See Section 3.2.3
			2 Remote Keypad Only	Use RUN button on optional Remote Keypad to start
			3 Network Only	<ul style="list-style-type: none"> Start command must come from network (Modbus, CANopen, etc) Requires optional communication module (refer to the network module documentation). Must also set one of the TB-13 inputs to 9 (Network Enable); see P121...P123
			4 Terminal Strip or Local Keypad	Allows start control to be switched between terminal strip and local keypad using one of the TB-13 inputs. See note below.
			5 Terminal Strip or Remote Keypad	Allows start control to be switched between terminal strip and optional remote keypad using one of the TB-13 inputs. See note below.
			6 CTRL Button Select	Allows start control to be switched between terminal strip and local keypad using the CTRL button. NOTE: P100 Selection 6 is applicable to 15 HP (11kW) and higher models only.
WARNING! P100 = 0 disables TB-1 as a STOP input! STOP circuitry may be disabled if parameters are reset back to defaults (see P199)				
Note <ul style="list-style-type: none"> P100 = 4, 5: To switch between control sources, one of the TB-13 inputs (P121...P123) must be set to 08 (Control Select); TB-13x OPEN (or not configured): Terminal strip control TB-13x CLOSED: Local (P100 = 4) or Remote (P100 = 5) keypad P100 = 0, 1, 4: Network can take control if P121...P123 = 9 and the corresponding TB-13x input is CLOSED. The STOP button on the front of the drive is always active except in JOG mode. An F.RL fault will occur if the Assertion Level switch (ALsw) position does not match the P120 setting and P100 is set to a value other than 0. 				

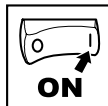
Commissioning



Code		Possible Settings			IMPORTANT	
No.	Name	Default	Selection			
P 101	Standard Reference Source	0	0 Keypad (Local or Remote)		Selects the default speed or torque reference when no Auto Reference is selected using the TB-13 inputs	
			1 0-10 VDC			
			2 4-20 mA			
			3 Preset #1			
			4 Preset #2			
			5 Preset #3			
			6 Network			
			7 Preset Sequence Segment #1		Selections 7, 8 & 9 are not valid for PID setpoint or torque reference.	
			8 Preset Sequence Segment #2			
9 Preset Sequence Segment #3						
P 102	Minimum Frequency	0.0	0.0	{Hz}	P103	<ul style="list-style-type: none"> P102, P103 are active for all speed references When using an analog speed reference, also see P160, P161
P 103	Maximum Frequency	60.0	7.5	{Hz}	500	
			 Note <ul style="list-style-type: none"> P103 cannot be set below Minimum Frequency (P102) To set P103 above 120 Hz: <ul style="list-style-type: none"> Scroll up to 120 Hz; display shows <i>H iFr</i> (flashing). Release ▲ button and wait one second Press ▲ button again to continue increasing P103 			
 WARNING! Consult motor/machine manufacturer before operating above rated frequency. Overspeeding the motor/machine may cause damage to equipment and injury to personnel!						
P 104	Acceleration Time 1	20.0	0.0	{s}	3600	<ul style="list-style-type: none"> P104 = time of frequency change from 0 Hz to P167 (base frequency) P105 = time of frequency change from P167 to 0 Hz For S-ramp accel/decel, adjust
P 105	Deceleration Time 1	20.0	0.0	{s}	3600	
			 Example: if P103 = 120 Hz, P104 = 20.0 s and P167 (base frequency) = 60 Hz; rate of frequency change from 0 Hz to 120 Hz = 40.0 s			
P 106	S-Ramp Integration Time	0.0	0.0	{s}	50.0	<ul style="list-style-type: none"> P106 = 0.0: Linear accel/decel ramp P106 > 0.0: Adjusts S-ramp curve for smoother ramp
P 107 ⁽¹⁾	Line Voltage Selection	1*	0 Low (120, 200, 400, 480VAC)		* The default setting is 1 for all drives except when using "reset 50" (Parameter P199, selection 4) with 480V models. In this case, the default setting is 0.	
			1 High (120, 240, 480, 600VAC)			

(1) Any changes to this parameter will not take effect until the drive is stopped





Commissioning

Code		Possible Settings			IMPORTANT	
No.	Name	Default	Selection			
P108	Motor Overload	100	30	{%}	100	<p>$P108 = \text{motor current rating} \times 100$ SM2 output rating Example: motor = 3 amps; SM2 = 4 amps; P108 = 75%</p> <p>Note Do not set above the rated motor current as listed on the motor dataplate. The motor thermal overload function of the SM2 is UL approved as a motor protection device. If line power is cycled, the motor thermal state is reset to cold state. Cycling power after an overload fault could result in significantly reducing the motor life.</p>
P109	Motor Overload Type	0	0 Speed Compensation			<p>V0108</p>
			1 No Speed Compensation			
P110	Start Method	0	0 Normal			
			1 Start on Power-up			Drive will automatically start when power is applied.
			2 Start with DC Brake			When start command is applied, drive will apply DC braking according to P174, P175 prior to starting the motor
			3 Auto Restart			Drive will automatically restart after faults, or when power is applied.
			4 Auto Restart with DC Brake			Combines settings 2 and 3
			5 Flying Start/Restart #1			<ul style="list-style-type: none"> Drive will automatically restart after faults, or when power is applied. After 3 failed attempts, drive will Auto Restart with DC brake. P110 = 5: Performs speed search, starting at Max Frequency (P103)
			6 Flying Start/Restart #2			<ul style="list-style-type: none"> P110 = 6: Performs speed search, starting at the last output frequency prior to faulting or power loss If P111 = 0, a flying START is performed when a start command is applied.

Commissioning



Code		Possible Settings		IMPORTANT
No.	Name	Default	Selection	
		 <p>Note</p> <ul style="list-style-type: none"> • P110 = 0, 2: Start command must be applied at least 2 seconds after power-up; <i>F.UF</i> fault will occur if start command is applied too soon. • P110 = 1, 3...6: For automatic start/restart, the start source must be the terminal strip and the start command must be present. • P110 = 2, 4...6: If P175=999.9, dc braking will be applied for 15s. • P110 = 3...6: Drive will attempt 5 restarts; if all restart attempts fail, drive displays <i>LC</i> (fault lockout) and requires manual reset. • P110 = 5, 6: If drive cannot catch the spinning motor, drive will trip into <i>F.rF</i> fault. 		
 <p>WARNING! Automatic starting/restarting may cause damage to equipment and/or injury to personnel! Automatic starting/restarting should only be used on equipment that is inaccessible to personnel.</p>				
P111	Stop Method	0	0 Coast	Drive's output will shut off immediately upon a stop command, allowing the motor to coast to a stop
			1 Coast with DC Brake	The drive's output will shut off and then the DC Brake will activate (see P174, P175)
			2 Ramp	The drive will ramp the motor to a stop according to P105 or P126.
			3 Ramp with DC Brake	The drive will ramp the motor to 0 Hz and then the DC Brake will activate (see P174, P175)
P112	Rotation	0	0 Forward Only	If PID mode is enabled, reverse direction is disabled (except for Jog).
			1 Forward and Reverse	

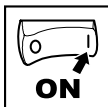

Commissioning

4.5.2 I/O Setup Parameters

Code		Possible Settings		IMPORTANT
No.	Name	Default	Selection	
P113	Auto/Manual Control	0	0 Terminal Strip Control	The reference is dictated by the settings and state of the TB-13x terminals. If no AUTO reference has been setup on the terminal strip then reference control is dictated by P101.
			1 Auto/Manual (CTRL button select)	Allows the reference to be switched between auto and manual using the CTRL pushbutton on the drive keypad. If the CTRL pushbutton has selected AUTO reference but no AUTO reference has been setup on the terminal strip, then reference control is dictated by P101.
			2 Manual Control Only	Reference is dictated by P101 regardless of any AUTO source that may be selected by the TB-13x terminals.
			NOTE P113 is applicable to 15 HP (11kW) and higher models only.	
P115	MOP Speed Initialization at Power-Up	0	0 Set to last MOP speed at power up	
			1 Set to 0.0Hz at power up	
			2 Set to Preset #3 at power up	
P120	Assertion Level	2	1 Low	P120 and the Assertion Level switch must both match the desired assertion level unless P100, P121 ... P123 are all set to 0. Otherwise an F.RL fault will occur.
			2 High	

Commissioning



Code		Possible Settings		IMPORTANT
No.	Name	Default	Selection	
P 121	TB-13A Input Function	0	0 None	Disables input
P 122	TB-13B Input Function		1 AUTO Reference: 0-10 VDC	For frequency mode, see P160...P161, For PID mode, see P204...P205, For vector torque mode, see P330
			2 AUTO Reference: 4-20 mA	
P 123	TB-13C Input Function		3 AUTO Reference: Preset	For frequency mode see P131...P137, For PID mode, see P231...P233, For torque mode see, P331...P333
			4 AUTO Reference: MOP Up	
P 124	TB-13D* Input Function		5 AUTO Reference: MOP Down	<ul style="list-style-type: none"> Normally open: Close input to increase or decrease speed, PID setpoint or torque setpoint. MOP Up is not active while in STOP
			6 AUTO Reference: Keypad	
			7 AUTO Reference: Network	
			8 Control Select	Use when P100 = 4, 5 to switch between terminal strip control and local or remote keypad control.
			9 Network Enable	Required to start the drive through the network.
			10 Reverse Rotation	Open = Forward Closed = Reverse
			11 Start Forward	See note for typical circuit
			12 Start Reverse	
			13 Run Forward	See note for typical circuit
			14 Run Reverse	
			15 Jog Forward	Jog Forward speed = P134
			16 Jog Reverse	Jog Reverse speed = P135 ⚠ WARNING! Active even if P112 = 0
			17 Accel/Decel #2	See P125, P126
			18 DC Brake	See P174; close input to override P175
			19 Auxiliary Ramp to Stop	Normally closed: Opening input will ramp drive to STOP according to P127, even if P111 is set to Coast (0 or 1).
			20 Clear Fault	Close to reset fault
			21 External Fault F.EF	Normally closed circuit; open to trip
			22 Inverse External Fault F.EF	Normally open circuit; close to trip
23 AUTO Ref: Sequence Segment #1	Works in Speed Mode only			
24 Start Sequence				
25 Step Sequence	Transition from non-asserted to asserted state			
	26 Suspend Sequence			



NOTE: P124 is applicable to SMV 15HP (11kW) and greater models only



WARNING!

Jog overrides all STOP commands! To stop the drive while in Jog mode, the Jog input must be deactivated or a fault condition induced.



Commissioning

Code		Possible Settings				IMPORTANT
No.	Name	Default	Selection			
<p>WARNING! If the input defined to "Start Sequence" is opened during a sequence, the drive will exit sequencer mode and will run at the specified standard or alternate speed source (dependent on drive configuration).</p>						
<p>Note</p> <ul style="list-style-type: none"> When input is activated, settings 1...7 override P101 When TB-13A...TB-13C are configured for Auto References other than MOP, TB-13C overrides TB-13B, and TB-13B overrides TB-13A. Any other Auto Reference will have priority over MOP. Settings 10...14 are only valid in Terminal Strip mode (P100 = 1, 4, 5) If Start/Run/Jog Forward and Start/Run/Jog Reverse are both activated, drive will STOP If Jog input is activated while the drive is running, the drive will enter Jog mode; when Jog input is deactivated, drive will STOP An <i>F. RL</i> fault will occur if the Assertion Level switch (ALsw) position does not match the P120 setting and any of the digital inputs (P121...P123) are set to a value other than 0. An <i>F. I L</i> fault will occur under the following conditions: <ul style="list-style-type: none"> TB-13A...TB-13C settings are duplicated (each setting, except 0 and 3, can only be used once) One input is set to "MOP Up" and another is not set to "MOP Down", or vice-versa. One input is set to 10 and another input is set to 11...14. One input is set to 11 or 12 and another input is set for 13 or 14. Typical control circuits are shown below: <ul style="list-style-type: none"> If any input is set to 10, 12 or 14, P112 must be set to 1 for Reverse action to function. 						
<div style="display: flex; justify-content: space-around; align-items: flex-start;"> <div style="text-align: center;"> <p>Run / Stop with Direction P121 = 10</p> </div> <div style="text-align: center;"> <p>Start Forward / Start Reverse P121 = 11, P122 = 12</p> </div> <div style="text-align: center;"> <p>Run Forward / Run Reverse P121 = 13, P122 = 14</p> </div> </div>						
P 125	Acceleration Time 2	20.0	0.0	{s}	3600	<ul style="list-style-type: none"> Selected using TB-13A...TB-13C (P121...P123 = 17) For S-ramp accel/decel, adjust P106
P 126	Deceleration Time 2	20.0	0.0	{s}	3600	
P 127	Deceleration Time for Auxiliary Ramp to Stop	20.0	0.0	{s}	3600	<ul style="list-style-type: none"> Selected using TB-13A...TB-13C (P121...P123 = 19). For S-ramp accel/decel, adjust P106 Once executed, this ramp time has priority over P105 and P126.
P 129	Automatic Accel/Decel rate switch threshold	0.0	0.0	{Hz}	1000	<p>If Actual Frequency < P129 Use Accel/decel time #2 (P126/P127)</p> <p>If Actual Frequency ≥ P129 Use Accel/decel time #1 (P104/P105)</p>

Commissioning

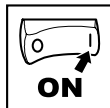

Code		Possible Settings				IMPORTANT																																																							
No.	Name	Default	Selection																																																										
P 131	Preset Speed #1	0.0	0.0	{Hz}	500	<table border="1"> <thead> <tr> <th>PRESET SPEED</th> <th>13A</th> <th>13B</th> <th>13C</th> <th>13D</th> </tr> </thead> <tbody> <tr><td>1</td><td>X</td><td>--</td><td>--</td><td>--</td></tr> <tr><td>2</td><td>--</td><td>X</td><td>--</td><td>--</td></tr> <tr><td>3</td><td>--</td><td>--</td><td>X</td><td>--</td></tr> <tr><td>4</td><td>X</td><td>X</td><td>--</td><td>--</td></tr> <tr><td>4 (alternate)</td><td>--</td><td>--</td><td>--</td><td>X</td></tr> <tr><td>5</td><td>X</td><td>--</td><td>X</td><td>--</td></tr> <tr><td>6</td><td>--</td><td>X</td><td>X</td><td>--</td></tr> <tr><td>7</td><td>X</td><td>X</td><td>X</td><td>--</td></tr> <tr><td>8 (alternate)</td><td>--</td><td>X</td><td>--</td><td>X</td></tr> <tr><td>8 (alternate)</td><td>--</td><td>--</td><td>X</td><td>X</td></tr> </tbody> </table> <ul style="list-style-type: none"> • Speed setting is used by P158 • 13D available on 15HP (11kW) & higher drives. 	PRESET SPEED	13A	13B	13C	13D	1	X	--	--	--	2	--	X	--	--	3	--	--	X	--	4	X	X	--	--	4 (alternate)	--	--	--	X	5	X	--	X	--	6	--	X	X	--	7	X	X	X	--	8 (alternate)	--	X	--	X	8 (alternate)	--	--	X	X
PRESET SPEED	13A	13B	13C	13D																																																									
1	X	--	--	--																																																									
2	--	X	--	--																																																									
3	--	--	X	--																																																									
4	X	X	--	--																																																									
4 (alternate)	--	--	--	X																																																									
5	X	--	X	--																																																									
6	--	X	X	--																																																									
7	X	X	X	--																																																									
8 (alternate)	--	X	--	X																																																									
8 (alternate)	--	--	X	X																																																									
P 132	Preset Speed #2	0.0	0.0	{Hz}	500																																																								
P 133	Preset Speed #3	0.0	0.0	{Hz}	500																																																								
P 134	Preset Speed #4	0.0	0.0	{Hz}	500																																																								
P 135	Preset Speed #5	0.0	0.0	{Hz}	500																																																								
P 136	Preset Speed #6	0.0	0.0	{Hz}	500																																																								
P 137	Preset Speed #7	0.0	0.0	{Hz}	500																																																								
P 138	Preset Speed #8	0.0	0.0	{Hz}	500																																																								
P 140	Relay Output TB-16, 17	0	0	None	Disables the output																																																								
			1	Run	Energizes when the drive is running																																																								
			2	Reverse	Energizes when reverse rotation is active																																																								
			3	Fault	De-energizes when the drive trips, or power is removed																																																								
			4	Inverse Fault	Energizes when the drive trips																																																								
			5	Fault Lockout	P110 = 3...6: De-energizes if all restart attempts fail																																																								
			6	At Speed	Energizes when output frequency = commanded frequency																																																								
			7	Above Preset Speed #6	Energizes when output freq. > P136																																																								
			8	Current Limit	Energizes when motor current = P171																																																								
			9	Follower Loss (4-20 mA)	Energizes when 4-20 mA signal falls below 2 mA																																																								
10	Loss of Load	Energizes when motor load drops below P145; see also P146																																																											





Commissioning

Code		Possible Settings		IMPORTANT
No.	Name	Default	Selection	
P 140 (cont)	Relay Output TB-16, 17	0	11 Local Keypad Control Active	Energizes when the selected source is active for start control
			12 Terminal Strip Control Active	
			13 Remote Keypad Control Active	
			14 Network Control Active	Energizes when P101 reference is active
			15 Standard Reference Active	
			16 Auto Reference Active	Energizes when Auto Reference is activated using TB-13 input; see P121...P123
			17 Sleep Mode Active	See P240...P242
			18 PID Feedback < Min. Alarm	Energizes when PID feedback signal < P214
			19 Inverse PID Feedback < Min. Alarm	De-energizes when PID feedback signal < P214
			20 PID Feedback > Max Alarm	Energizes when PID feedback signal > P215
			21 Inverse PID Feedback > Max Alarm	De-energizes when PID feedback signal > P215
			22 PID Feedback within Min/Max Alarm range	Energizes when PID feedback signal is within the Min/Max Alarm range; see P214, P215
			23 PID Feedback outside Min/Max Alarm range	Energizes when PID feedback signal is outside the Min/Max Alarm range; see P214, P215
			24 Reserved	
			25 Network Activated	Requires optional communication module (refer to the network module documentation).
			26 Loss of 0-10V Input	
27 Sequencer Controlled	State set in individual sequencer segments			
28 Sequencer Active				
29 Sequencer Suspended				
30 Sequence Done	End Sequence			
31 Actual Speed = 0.0Hz				
P 142	TB-14 Output	0	0...23 (same as P140)	
			24 Dynamic Braking	For use with Dynamic Braking option
			25...31 (same as P140)	

Commissioning



Code		Possible Settings			IMPORTANT																
No.	Name	Default	Selection																		
P 144	Digital Output Inversion		<table border="1"> <thead> <tr> <th>P144</th> <th>Invert P142</th> <th>Invert P140</th> </tr> </thead> <tbody> <tr> <td>0</td> <td>NO</td> <td>NO</td> </tr> <tr> <td>1</td> <td>NO</td> <td>YES</td> </tr> <tr> <td>2</td> <td>YES</td> <td>NO</td> </tr> <tr> <td>3</td> <td>YES</td> <td>YES</td> </tr> </tbody> </table>		P144	Invert P142	Invert P140	0	NO	NO	1	NO	YES	2	YES	NO	3	YES	YES	<p>Used to invert the selections for P140 (Relay Output) and P142 (TB-14 Output). EXAMPLE: When P140 = 6 (AT SPEED), the relay is energized when output frequency = commanded frequency. IF P144 = 1 or 3, then P140 is inverted (INVERSE AT SPEED) and the relay is energized when the output frequency does not equal the command frequency.</p>	
			P144	Invert P142	Invert P140																
			0	NO	NO																
1	NO	YES																			
2	YES	NO																			
3	YES	YES																			
<p> NOTE Inverting P140 or P142 when the parameter is set to NONE (0) will result in the output being energized continuously.</p>																					
<p> NOTE For SM Vector drives rated at 0.33 to 10 HP (0.25 to 7.5 kW), P144 is only available with software versions 3.0 and higher (refer to P501).</p>																					
P 145	Loss of Load Threshold	0	0	{%}	200	P140, P142 = 10: Output will energize if motor load falls below P145 value longer than P146 time															
P 146	Loss of Load Delay	0.0	0.0	{s}	240.0																
P 149	Analog Offset	0.0	0	{%}	100	Scaled value. Example: P149 = 10%, Scaled variable = freq., P150 = 1, P152 = 60Hz; then TB30 = 0VDC below 6HZ															
P 150	TB-30 Output	0	0 None		2-10 VDC signal can be converted to 4-20 mA with a total circuit impedance of 500 Ω																
			1 0-10 VDC Output Frequency																		
			2 2-10 VDC Output Frequency																		
			3 0-10 VDC Load																		
			4 2-10 VDC Load																		
			5 0-10 VDC Torque																		
			6 2-10 VDC Torque																		
			7 0-10 VDC Power (kW)																		
			8 2-10 VDC Power (kW)																		
			9 Network Controlled				Requires optional communication module (refer to the network module documentation).														
10 Sequencer Controlled		Value set in individual sequencer segments																			
P 152	TB-30 Scaling: Frequency	60.0	3.0	{Hz}	2000	If P150 = 1 or 2, sets the frequency at which output equals 10 VDC															
P 153	TB-30 Scaling: Load	200	10	{%}	500	If P150 = 3 or 4, sets the Load (as a percent of drive current rating) at which output equals 10 VDC.															



Commissioning

Code		Possible Settings				IMPORTANT
No.	Name	Default	Selection			
P 154	TB-30 Scaling: Torque	100	10	{%}	1000	If P150 = 5 or 6, sets the Torque (as a percent of motor rated torque) at which output equals 10 VDC
P 155	TB-30 Scaling: Power (kW)	1.0	0.1	{kW}	200.0	If P150 = 7 or 8, sets the power at which output equals 10 VDC
P 156	Analog Inputs Configuration		0	TB5: (0 - 10 VDC); TB25: (4-20mA)		
			1	TB5: (0 - 5 VDC); TB25: (4-20mA)		
			2	TB5: (2 - 10 VDC); TB25: (4-20mA)		
			3	TB5: (-10 - +10 VDC); TB25: (4-20mA)		Available on special option module only
			4	TB5: (0 - 10 VDC); TB25: (0-20mA)		
			5	TB5: (0 - 5 VDC); TB25: (0-20mA)		
			6	TB5: (2 - 10 VDC); TB25: (0-20mA)		
P 157	TB5 (0 - 10 VDC) Analog Input Monitoring Action		0	No Action		Selects the reaction to a loss of the 0-10 V signal at TB5
			1	P157 < P158 - Trip Fault F_{FAU}		
			2	P157 < P158 - Run Preset #8		
			3	P157 < P158 - Run Preset Seq. #16		Minimum time above/below Monitoring Level (P158) before triggering action is 500ms.
			4	P157 > P158 - Trip Fault F_{FAU}		
			5	P157 > P158 - Run Preset *8		
			6	P157 > P158 - Run Preset Seq. #16		
P 158	TB5 (0-10V) Analog Input Monitoring Level (ML)	0.0	-10.0	{VDC}	10.0	
P 159	0-10V Analog Input Deadband	0.0	0	{VDC}	10.0	Not active if [-10 to +10 VDC] option is selected.

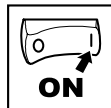

4.5.3 Advanced Setup Parameters

Code		Possible Settings				IMPORTANT
No.	Name	Default	Selection			
P 160	Speed at Minimum Signal	0.0	-999.0	{Hz}	1000	<p style="text-align: right;">V0111</p>
P 161	Speed at Maximum Signal	60.0	-999.0	{Hz}	1000	
		Note <ul style="list-style-type: none"> P160 sets the output frequency at 0% analog input P161 sets the output frequency at 100% analog input P160 or P161 < 0.0 Hz: For scaling purposes only; does not indicate opposite direction! P160 > P161: Drive will react inversely to analog input signal 				
P 162	Analog Input Filter	0.01	0.00	{s}	10.00	Adjusts the filter on the analog inputs (TB-5 and TB-25) to reduce the effect of signal noise
P 163	TB-25 Loss Action	0	0 No Action 1 Fault $F.FoL$ 2 Go to Preset when TB-25 is: Speed reference: P137 PID feedback source: P137 PID setpoint reference: P233 Torque reference: P333			<ul style="list-style-type: none"> Selects the reaction to a loss of the 4-20 mA signal at TB-25. Signal is considered lost if it falls below 2 mA Digital outputs can also indicate a loss of 4-20 mA signal; see P140, P142
P 164	TB-25 (4-20mA) Analog Input Monitoring Level	2.0	0.0	{mA}	10.0	
P 165	Base Voltage		15	{V}	1000	Valid for V/Hz mode only. Set voltage for bus compensation in V/Hz mode
P 166	Carrier Frequency	1	0 4 kHz 1 6 kHz 2 8 kHz 3 10 kHz			<ul style="list-style-type: none"> As carrier frequency is increased, motor noise is decreased Observe derating in Section 2.2 Automatic shift to 4 kHz at 120% load

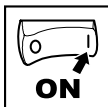



Commissioning

Code		Possible Settings				IMPORTANT
No.	Name	Default	Selection			
P 157 ⁽¹⁾	Base Frequency	60.0	10.0	{Hz}	1500	
P 168	Fixed Boost		0.0	{%}	30.0	
			Note <ul style="list-style-type: none"> • P167 = rated motor frequency for standard applications • P168 default setting depends on drive rating 			
P 169	Accel Boost	0.0	0.0	{%}	20.0	Accel Boost is only active during acceleration
P 170	Slip Compensation	0.0	0.0	{%}	10.0	Increase P170 until the motor speed no longer changes between no load and full load conditions.
P 171 ⁽¹⁾	Current Limit	200	30	{%}	CLim _{max}	<ul style="list-style-type: none"> • When the limit is reached, the drive displays [L], and either the acceleration time increases or the output frequency decreases. • Digital outputs can also indicate when the limit is reached; see P140, P142. • Refer to section 2.2 for CLim_{max}
P 172	Current Limit Reduction	0	0 Current Limit Reduction Active - Normal response 1 Current Limit Reduction Active - Fast response 2 Current Limit Reduction Disabled - Normal response 3 Current Limit Reduction Disabled - Fast response			In field weakening, the Current Limit is inversely proportional to the speed.
P 173	Decel Override Time	2.0	0.0	{s}	60.0	Maximum time before drive trips into HF fault.
P 174	DC Brake Voltage	0.0	0.0	{%}	30.0	Setting is a percent of the nominal DC bus voltage.

(1) The drive can only be restarted if the error message has been reset

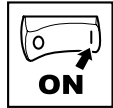
Commissioning



Code		Possible Settings			IMPORTANT	
No.	Name	Default	Selection			
P 175	DC Brake Time	0.0	0.0	{s}	999.9	
			<p>Note</p> <p>CONFIRM MOTOR SUITABILITY FOR USE WITH DC BRAKING</p> <p>DC Brake voltage (P174) is applied for the time specified by P175 with the following exceptions:</p> <ul style="list-style-type: none"> • If P111=1, 3 and P175=999.9 the brake voltage will be applied continuously until a run or fault condition occurs. • If P110=2, 4...6 and P175=999.9, brake voltage will be applied for 15s • If P121...P123=18 and the corresponding TB-13 input is CLOSED, brake voltage will be applied until the TB-13 input is OPENED or a fault condition occurs. 			
P 176	Keypad Setpoint Single Press Increment	0.1	0.1		100.0	Used for run screen setpoint editing only. If P176>0.1 then scrolling of keypad setpoint is disabled.
P 177 ⁽²⁾	Speed Units	0	0	Hz		Select the UNITS LED that will be illuminated when the drive is running in speed control mode. For this parameter to be used, P178 must be set to a value other than 0. IF P178 is set to 0, the Hz LED will be illuminated regardless of the value set in P177.
			1	RPM		
			2	%		
			3	/UNITS		
			4	NONE		
P 178	Display Frequency Multiplier	0.00	0.00		650.00	<ul style="list-style-type: none"> • Allows frequency display to be scaled • P178 = 0.00: Scaling disabled • P178 > 0.00: Display = Actual Frequency X P178
			<p>Example: If P178 = 29.17 and actual frequency = 60 Hz, Drive displays 1750 (rpm)</p>			
P 179	Run Screen Display	0	0	{Parameter Number}	599	<ul style="list-style-type: none"> • 0 = Normal Run Screen, this display depends on mode of operation. See Section 4.2. • Other selections choose a diagnostic parameter to display (P501...P599). • Parameters P560 - P564 are selectable if the sequencer is enabled (P700 is not 0). P560 - P564 are not visible until P700 is enabled.
P 180	Oscillation Damping Control	0	0		80	0 = Damping disabled Compensation for resonances within drive

(2) Parameter applicable to models 15HP (11kW) and higher.

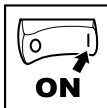



Commissioning

Code		Possible Settings				IMPORTANT
No.	Name	Default	Selection			
P 181	Skip frequency 1	0.0	0.0	{Hz}	500	<ul style="list-style-type: none"> Drive will not run in the defined skip range; used to skip over frequencies that cause mechanical vibration P181 and P182 define the start of the skip ranges P184 > 0 defines the bandwidth of both ranges.
P 182	Skip frequency 2	0.0	0.0	{Hz}	500	
P 184	Skip frequency bandwidth	0.0	0.0	{Hz}	10.0	
		Note Bandwidth (Hz) = f_s (Hz) + P184 (Hz) f_s = P181 or P182 Example: P181 = 18 Hz and P184 = 4 Hz; skip range is from 18 to 22 Hz				
P 185	Voltage Midpoint V/Hz characteristic	0	0.0	{V}	P165	Valid only when P300 = 0 or 2. Use with P187 to define midpoint on V/Hz curve.
P 187 ⁽²⁾	Frequency Midpoint V/Hz characteristic	0.0	0.0	{Hz}	P167	Valid only when P300 = 0 or 2. Use with P185 to define midpoint on V/Hz curve.
P 190	Motor Braking		0 Disabled 1 Braking with BUS threshold 2 Braking always on with deceleration 3 Braking with bus regulator 4 Special (Consult factory before using)			
P 191	Motor Brake Level	0	0	{%}	75	Active when P190 > 0 and drive is in deceleration mode. Use to reduce deceleration time on high inertia loads. NOTE: Over usage of P190 can cause frequent 'overload' trips "F.PF" Not active for P300 = 5 (Torque mode)
P 192	Motor Braking Deceleration Reduction Level	0.0	0		P167 (base freq)	Active when P190 > 0 and P192 > 0.0, Drive is in deceleration mode. Use to reduce deceleration time on high inertia loads. NOTE: Usage of P192 can cause the drive to decelerate faster than settings in P105/P127. Not active for P300 = 5 (Torque mode)
			Raising the value of P191 reduces the drive deceleration rate during flux braking.			
P 194	Password	225	0000		9999	<ul style="list-style-type: none"> Must enter password to access parameters P194 = 0000: Disables password

(2) Parameter applicable to models 15HP (11kW) and higher.

Commissioning



Code		Possible Settings		IMPORTANT
No.	Name	Default	Selection	
P 197	Clear Fault History	0	0 No Action 1 Clear Fault History	
P 199	Program Selection		0 Operate from User settings	
			1 Operate from OEM settings	See Notes 1, 2 and 3
			2 Reset to OEM default settings	See Note 1
			3 Reset to 60 Hz default settings	<ul style="list-style-type: none"> See Note 4 Parameters are reset to the defaults listed in this manual. For P199=4, the following exceptions apply: <ul style="list-style-type: none"> - P103, P152, P161, P167 = 50.0 Hz - P304 = 50 Hz; - P305 = 1450 RPM - P107 = 0 (480 V drives only)
			4 Reset to 50 Hz default settings	
			5 Translate	See Note 5
		 WARNING! Modification of P199 can affect drive functionality! STOP and EXTERNAL FAULT circuitry may be disabled! Check P100 and P121...P123		
		 <p>Note 1 If the EPM does not contain valid OEM settings, a flashing GF will be displayed when P199 is set to 1 or 2.</p> <p>Note 2 When P199 is set to 1, the drive operates from the OEM settings stored in the EPM Module and no other parameters can be changed (GE will be displayed if attempted).</p> <p>Note 3 Auto Calibration is not possible when operating from OEM Settings.</p> <p>Note 4 Reset 60 and Reset 50 will set the Assertion Level (P120) to "2" (High). P120 may need to be reset for the digital input devices being used. An F.RL fault may occur if P120 and the Assertion switch are not set identically.</p> <p>Note 5 If an EPM that contains data from a previous compatible software version is installed:</p> <ul style="list-style-type: none"> The drive will operate according to the previous data, but parameters cannot be changed (cE will be displayed if attempted) To update the EPM to the current software version, set P199 = 5. The parameters can now be changed but the EPM is incompatible with previous software revisions. 		

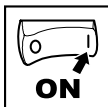

Commissioning

4.5.4 PID Parameters

Code		Possible Settings		IMPORTANT	
No.	Name	Default	Selection		
P200	PID Mode	0	0 Disabled	<ul style="list-style-type: none"> Normal-acting: As feedback increases, motor speed decreases Reverse-acting: As feedback increases, motor speed increases PID mode is disabled in Vector Torque mode (P300 = 5) Selections 3, 4: If P112=1, PID controller output sets the speed, (range -max freq to +max freq) 	
			1 Normal-acting		
			2 Reverse-acting		
			3 Normal-acting, Bi-directional		
			4 Reverse-acting, Bi-directional		
		 Note To activate PID mode, one of the TB-13 inputs (P121...P123) must be used to select the Auto Reference that matches the desired PID setpoint reference. If the selected PID setpoint reference uses the same analog signal as the PID feedback (P201), an <i>F.I.L</i> fault will occur. Example: The desired PID setpoint reference is the keypad (▲ and ▼). Set TB-13x = 6 (Auto Reference: Keypad): <ul style="list-style-type: none"> TB-13x = closed: PID mode is active TB-13x = open: PID mode is disabled and the drive speed will be controlled by the reference selected in P101. 			
P201	PID Feedback Source	0	0 4-20 mA (TB-25) 1 0-10 VDC (TB-5)	Must be set to match the PID feedback signal	
P202	PID Decimal Point	1	0 PID Display = XXXX 1 PID Display = XXX.X 2 PID Display = XX.XX 3 PID Display = X.XXX 4 PID Display = .XXXX	Applies to P204, P205, P214, P215, P231...P233, P242, P522, P523	
P203 ⁽²⁾	PID Units	0	0 % 1 /UNITS 2 AMPS 3 NONE	Select the UNITS LED that will be illuminated when the drive is running in PID control mode	
P204	Feedback at Minimum Signal	0.0	-99.9	3100.0	Set to match the range of the feedback signal being used
P205	Feedback at Maximum Signal	100.0	-99.9	3100.0	Example: Feedback signal is 0 - 300 PSI; P204 = 0.0, P205 = 300.0

(2) Parameter applicable to models 15HP (11kW) and higher.

Commissioning



Code		Possible Settings				IMPORTANT
No.	Name	Default	Selection			
P207	Proportional Gain	5.0	0.0	{%}	100.0	Used to tune the PID loop: <ul style="list-style-type: none"> • Increase P207 until system becomes unstable, then decrease P207 by 10-15% • Next, increase P208 until feedback matches setpoint • If required, increase P209 to compensate for sudden changes in feedback
P208	Integral Gain	0.0	0.0	{s}	20.0	
P209	Derivative Gain	0.0	0.0	{s}	20.0	
		 Note <ul style="list-style-type: none"> • Derivative Gain is very sensitive to noise on the feedback signal and must be used with care • Derivative Gain is not normally required in pump and fan applications 				
P210	PID Setpoint Ramp	20.0	0.0	{s}	100.0	<ul style="list-style-type: none"> • time of setpoint change from P204 to P205 or vice versa. • Used to smooth the transition from one PID setpoint to another, such as when using the Preset PID Setpoints (P231...P233)
P214	Minimum Alarm	0.0	P204		P205	Use with P140, P142 = 18...23
P215	Maximum Alarm	0.0	P204		P205	
P231	Preset PID Setpoint #1	0.0	P204		P205	TB-13A activated; P121 = 3 and P200 = 1 or 2
P232	Preset PID Setpoint #2	0.0	P204		P205	TB-13B activated; P122 = 3 and P200 = 1 or 2
P233	Preset PID Setpoint #3	0.0	P204		P205	TB-13C activated; P123 = 3 and P200 = 1 or 2
P234	Preset PID Setpoint #4	0.0	P204		P205	TB-13D activated; P124 = 3 and P200 = 1 or 2
P240	Sleep Threshold	0.0	0.0	{Hz}	500.0	<ul style="list-style-type: none"> • If drive speed < P240 for longer than P241, output frequency = 0.0 Hz; drive display = SLP • P240 = 0.0: Sleep mode is disabled. • P200 = 0...2: Drive will start again when speed command is above P240 • P242 > 0.0: Drive will restart when the PID feedback differs from the setpoint by more than the value of P242 or when the PID loop requires a speed above P240.
P241	Sleep Delay	30.0	0.0	{s}	300.0	
P242	Sleep Bandwidth	0.0	0.0		B _{max}	
		Where: $B_{max} = [(P205 - P204)]$				
P243	Feedback Sleep Entry Threshold	0.0	P204		P205	Active only when P244 = 1 or 2

(2) Parameter applicable to models 15HP (11kW) and higher.



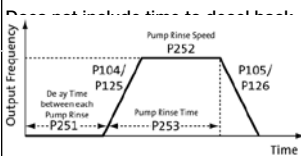

Commissioning

Code		Possible Settings			IMPORTANT
No.	Name	Default	Selection		
P244	Sleep Entry Mode	0	0	Enter SLEEP if Drive Speed <P240	For time longer than P241
			1	Enter SLEEP if Feedback >P243	For time longer than P241 or same as Sel 0
			2	Enter SLEEP if Feedback <P243	For time longer than P241 or same as Sel 0
P245	Sleep Entry Stop Type	0	0 Coast to Stop 1 Ramp to Stop 2 Stop with P111 settings		
P246	Feedback Recovery from Sleep Threshold	0.0	P204 P205	Active only when P247 = 1 or 2	
P247	Sleep Recovery Mode	0	0	Recovery if Speed Setpoint > P240 or if PID feedback differs from setpoint by more than P242	
			1	Recovery only if Feedback < P246	
			2	Recovery only if Feedback > P246	
P250	Auto Rinse in Sleep Mode	0	0	Disabled	Activated in sleep mode only.
			1	Enabled	Sleep Recovery cancels Auto Rinse
P251	Time Delay between Auto Rinses	30.0	0.0 {min} 6553.5	Time delay reset by re/entering sleep mode	
P252	Auto Rinse Speed	0.0	-500.0 {Hz} 500.0	If P112 = 1, negative sign = reverse direction	
P253	Auto Rinse Time	0.0	0.0 {sec} 6553.5		
			Auto Pump Rinse Setup: P250=1 (Enabled) P251=# minutes between each Pump Rinse P252=Hz speed of Pump Rinse P253=# seconds Pump Rinse duration		





4.5.5 Vector Parameters

Code		Possible Settings			IMPORTANT	
No.	Name	Default	Selection			
P300 ⁽¹⁾	Drive Mode	0	0	Constant V/Hz	Constant torque V/Hz control for general applications	
			1	Variable V/Hz	Variable torque V/Hz control for centrifugal pump and fan applications	
			2	Enhanced Constant V/Hz	For single or multiple motor applications that require better performance than settings 0 or 1, but cannot use Vector mode, due to: <ul style="list-style-type: none"> • Missing required motor data • Vector mode causing unstable motor operation 	
			3	Enhanced Variable V/Hz		
			4	Vector Speed	For single-motor applications requiring higher starting torque and speed regulation	
			5	Vector Torque	For single-motor applications requiring torque control independent of speed	
			 Note To configure the drive for either Vector mode or Enhanced V/Hz mode: <ul style="list-style-type: none"> • P300 = 4, 5: <ul style="list-style-type: none"> - Set P302...P306 according to motor nameplate - Set P399 = 1 - Make sure motor is cold (20° - 25° C) and apply a Start command - Display will indicate CL for about 40 seconds - Once the calibration is complete, the display will indicate StoP; apply another Start command to actually start the motor - If an attempt is made to start the drive in Vector or Enhanced V/Hz mode before performing the Motor Calibration, the drive will display F.n Id and will not operate • P300 = 2, 3: Same as above but only need to set P302...P304 			
P302 ⁽¹⁾	Motor Rated Voltage		0	{V}	600	<ul style="list-style-type: none"> • Default setting = drive rating • Set to motor nameplate data
P303 ⁽¹⁾	Motor Rated Current		0.0	{A}	500.0	
P304 ⁽¹⁾	Motor Rated Frequency	60	0	{Hz}	1000	Set to motor nameplate data
P305 ⁽¹⁾	Motor Rated Speed	1750	300	{RPM}	65000	
P306 ⁽¹⁾	Motor Cosine Phi	0.80	0.40		0.99	
			 Note If motor cosine phi is not known, use one of the following formulas: $\cos \phi = \text{motor Watts} / (\text{motor efficiency} \times P302 \times P303 \times 1.732)$ $\cos \phi = \cos [\sin^{-1} (\text{magnetizing current} / \text{motor current})]$			

(1) The drive can only be restarted if the error message has been reset



Commissioning

Code		Possible Settings				IMPORTANT
No.	Name	Default	Selection			
P310 ⁽¹⁾	Motor Stator Resistance	0.00	0.00	{ Ω }	64.00	<ul style="list-style-type: none"> Will be automatically programmed by P399 Changing these settings can adversely affect performance. Contact factory technical support prior to changing
P311 ⁽¹⁾	Motor Stator Inductance	0.0	0.0	{mH}	2000	
P315	Dead Time Compensation Factor	0.0	-50.0	{%}	+50.0	<ul style="list-style-type: none"> Adjust dead time correction from internal default Takes effect when P399 = 3.
P330	Torque Limit	100	0	{%}	400	When P300 = 5, sets the maximum output torque.
P331	Preset Torque Setpoint #1	100	0	{%}	400	TB-13A activated; P121 = 3 and P300 = 5
P332	Preset Torque Setpoint #2	100	0	{%}	400	TB-13B activated; P122 = 3 and P300 = 5
P333	Preset Torque Setpoint #3	100	0	{%}	400	TB-13C activated; P123 = 3 and P300 = 5
P334 ⁽²⁾	Preset Torque Setpoint #4	100	0	{%}	400	TB-13D activated; P124 = 3 and P300 = 5
P340 ⁽¹⁾	Current Loop P Gain	0.25	0.00		16.0	Changing these settings can adversely affect performance. Contact factory technical support prior to changing.
P341 ⁽¹⁾	Current Loop I Gain	65	12	{ms}	9990	
P342 ⁽¹⁾	Speed Loop Adjustment	0.0	0.0	{%}	20.0	
P343	Slip Compensation Response Filter	99	90	{ms}	9999	Low pass filter time constant for varying the slip compensation response to changes in the motor current.

(1) Any changes to this parameter will not take effect until the drive is stopped

(2) Parameter applicable to models 15HP (11kW) and higher.

Commissioning



Code		Possible Settings		IMPORTANT
No.	Name	Default	Selection	
P399	Motor Auto-calibration	0	0 Calibration Not Done	<ul style="list-style-type: none"> • If P300 = 4 or 5, motor calibration must be performed if P399 is not set to 3 (bypass calibration). • If P300=2 or 3, motor calibration is recommended. • Use option 2 if option 1 failed or in case of nonstandard motors • An alternating CLL / Err will occur if: <ul style="list-style-type: none"> - attempt motor calibration with P300 = 0 or 1 - motor calibration is attempted before programming motor data
			1 Standard Calibration Enabled	
			2 Advanced Calibration Enabled	
			3 Bypass Calibration, enable operation in vector mode w/o Auto Calibration	
			4 Standard Calibration Complete	
			5 Advanced Calibration Complete	
		<div style="border: 1px solid black; padding: 5px;"> Note To run the Auto Calibration: <ul style="list-style-type: none"> - Set P302...P306 according to motor nameplate - Set P399 = 1 - Make sure motor is cold (20° - 25° C) - Apply a Start command - Display will indicate CLL for about 40 seconds - Once the calibration is complete, the display will indicate StoP; apply another Start command to actually start the motor - Parameter P399 will now be set to 2. </div>		

(1) Any changes to this parameter will not take effect until the drive is stopped

(2) Parameter applicable to models 15HP (11kW) and higher.



Commissioning

4.5.6 Network Parameters

Code		Possible Settings		IMPORTANT
No.	Name	Default	Selection	
P400	Network Protocol		0 Not Active 1 Remote Keypad 2 Modbus RTU 3 CANopen 4 DeviceNet 5 Ethernet 6 Profibus 7 Lecom-B 8 I/O Module	This parameter will only display the selection for the module that is installed.
P401	Module Type Installed	0	0 No Module Installed 1 Basic I/O (0x0100, 1.0.0) 2 RS485/Rem. Keypad (0x0200, 2.0.0) 3 CANopen (0x0300, 3.0.0) 11 PROFIBUS (0x1100, 11.0.0) 12 Ethernet (0x1200, 12.0.0)	Module type format: 0xAABC; Drive Display: AA.B.C AA = Module Type B = Major revision C = minor revision
P402	Module Status	0	0 Not Initialized 1 Initialization: Module to EPM 2 Initialization: EPM to Module 3 Online 4 Failed Initialization Error 5 Time-out Error 6 Initialization Failed 7 Initialization Error	Module type mismatch P401 Protocol selection mismatch P400
P403	Module Reset	0	0 No Action 1 Reset parameters to default values	Returns module parameters 401...499 to the default values shown in the manual
P404	Module Timeout Action	0	0 No Fault 1 STOP (see P111) 2 Quick Stop 3 Fault (F_ntF)	Action to be taken in the event of a Module/Drive Time-out. Time is fixed at 200ms STOP is by the method selected in P111.



Code		Possible Settings		IMPORTANT
No.	Name	Default	Selection	
P405	Current Network Fault		0 No Fault	Netidle Mode Loss of Ethernet I/O connection Network Fault Explicit Message Timeout Overall Network Timeout Overall Explicit Timeout Overall I/O Message Timeout
			1 F.nF1	
			2 F.nF2	
			3 F.nF3	
			4 F.nF4	
			5 F.nF5	
			6 F.nF6	
			7 F.nF7	
P406	Proprietary			Manufacturer specific
P407 ... P499		Module Specific Parameters		Refer to the Communications Reference Guide specific to the network or I/O module installed.

4.5.7 Diagnostic Parameters

Code		Display Range (READ ONLY)	IMPORTANT
No.	Name		
P500	Fault History		<ul style="list-style-type: none"> Displays the last 8 faults Format: n.xxx where: n = 1..8; 1 is the newest fault xxx = fault message (without the F.) see Section 5.3
P501	Software version		Format: x.yz
P502	Drive ID		A flashing display indicates that the Drive ID stored in the EPM does not match the drive model it is plugged into.
P503	Internal Code		Alternating Display: xxx-; -yy
P505	DC Bus Voltage	0 {VDC} 1500	
P506	Motor Voltage	0 {VAC} 1000	
P507	Load	0 {%} 255	Motor load as % of drive's output current rating. See section 2.2.
P508	Motor Current	0.0 {A} 1000	Actual motor current
P509	Torque	0 {%} 500	Torque as % of motor rated torque (vector mode only)
P510	kW	0.00 {kW} 650.0	
P511	kWh	0.0 {kWh} 9999999	Alternating display: xxx-; yyyy when value exceeds 9999



Commissioning

Code		Display Range (READ ONLY)		IMPORTANT
No.	Name			
P5 I2	Heatsink Temp	0	{°C} 150	Heatsink temperature
P520	0-10 VDC Input	0.0	{VDC} 10.0	Actual value of signal at TB-5
P52 I	4-20 mA Input	0.0	{mA} 20.0	Actual value of signal at TB-25
P522	TB-5 Feedback	P204	P205	TB-5 signal value scaled to PID feedback units
P523	TB-25 Feedback	P204	P205	TB-25 signal value scaled to PID feedback units
P525	Analog Output	0	{VDC} 10.0	See P150...P155
P527	Actual Output Frequency	0	{Hz} 500.0	
P528	Network Speed Command	0	{Hz} 500.0	Command speed if (Auto: Network) is selected as the speed source
P530	Terminal and Protection Status			Indicates terminal status using segments of the LED display. (See section 4.5.7.1)
P53 I	Keypad Status			Indicates keypad button status using segments of the LED display. (See section 4.5.7.2)
P540	Total Run Time	0	{h} 9999999	Alternating display: xxx-; yyyy when value exceeds 9999
P54 I	Total Power On Time	0	{h} 9999999	
P550	Fault History	1	8	<ul style="list-style-type: none"> • Displays the last 8 faults • Format: n.xxx where: n = 1..8, 1 is the newest fault; xxx = fault message (w/o the F.) • Refer to section 5.3
P55 I	Fault History Time	0	{h} 999999	Display: "n.hh-" "hhhh" "mm.ss" = fault #, hours, seconds. The "hhhh" screen is displayed after hours exceed 999.
P552	Fault History Counter	0	255	Number of sequential occurrences of a fault. For example: 3 external faults occur over a period of time with no other errors occurring. Then P552 will indicate 3, P550 will indicate the error EF and P551 will indicate the time of the first fault occurrence.
P560	Sequencer: Currently Active Segment	0	17	
P56 I	Sequencer: Time since Start of Active Segment	0.0 0	{P708} 6553.5 {P708} 65535	Unit depends on P708 (0.1sec, sec or minutes)

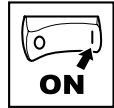

Code		Display Range (READ ONLY)	IMPORTANT
No.	Name		
P562	Sequencer: Time Remaining in Active Segment	0.0 0 {P708} 6553.5 65535	Unit depends on P708 (0.1sec, sec or minutes)
P563	Sequencer: Number of cycles since start	0 65535	
P564	Sequencer: Number of cycles remaining	0 65535	
		Note: Parameters P560-P564 are visible only when P700 > 0 (i.e. the sequencer is enabled)	

4.5.7.1 Terminal and Protection Status Display

Parameter P530 allows monitoring of the control terminal points and common drive conditions:

An illuminated LED segment indicates:

- the protective circuit is active (LED 1)
- the Logic Assertion Switch is set to High (+)
- input terminal is asserted (LED 2)
- output terminal is energized (LED 4)
- the Charge Relay is not a terminal, this segment will be illuminated when the Charge Relay is energized (LED 4)

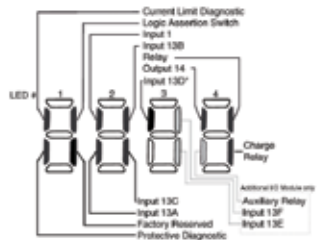

4.5.7.2 Keypad Status Display

Parameter P531 allows monitoring of the keypad pushbuttons:

An illuminated LED segment indicates when the button is depressed.

LED 1 and LED 2 are used to indicate pushbutton presses on a remote keypad that is attached to the drive. LED 3 and LED 4 indicate button presses on the local drive keypad.

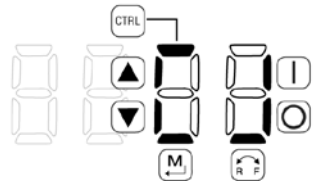

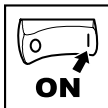



Commissioning

4.5.8 Onboard Communications Parameters 15-30HP (11-22kW)

The P6xx Onboard Communication parameters are applicable to the 15HP (11kW) and greater models only.

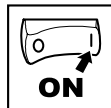
Code		Possible Settings		IMPORTANT
No.	Name	Default	Selection	
P600	Network Enable	0	0 Disabled 1 Remote Keypad 2 Modbus 7 Lecom	This parameter enables the onboard network communications.
			NOTE: Onboard Communications will be disabled if: - P600 = 0, or - P600 = 1 and P400 = 1, or - P600 = 2 and P400 = 2, 3, 4, 5, 6 or 7 - P600 = 7 and P400 = 2, 3, 4, 5, 6 or 7 If the onboard communications are disabled, the user will not have access to any of the other P6xx parameters.	
P610	Network Address	1	1 - 247	Modbus
		1	1 - 99	Lecom
P611	Network Baud Rate	2	0 2400 bps 1 4800 bps 2 9600 bps 3 19200 bps	Modbus
		0	0 9600 bps 1 4800 bps 2 2400 bps 3 1200 bps 4 19200 bps	Lecom
P612	Network Data Format	0	0 8, N, 2 1 8, N, 1 2 8, E, 1 3 8, O, 1	Modbus Only
		0	0 Monitor Only 1 Parameter Programming 2 Programming and Setpoint Control 3 Full Control	Lecom Only
P624	Network Powerup Start Status	0	0 Quick Stop 1 Controller Inhibit	Lecom Only
		P625	Network Timeout	10.0
50	0 - 65000 milliseconds			Lecom



Code		Possible Settings		IMPORTANT
No.	Name	Default	Selection	
P626	Network Timeout Action	4	0 No action 1 Stop (P111) 2 Quick Stop 3 Controller Inhibit 4 Trip Fault, F.nF1	Modbus
		0	0 No action 1 Controller Inhibit 2 Quick Stop 3 Trip Fault, F.nF1	Lecom
P627	Network Messages Received		Read-Only: 0 - 9999 NOTE: When the number of messages exceeds 9999, the counter resets and resumes counting from 0.	Valid network messages received

4.5.9 Sequencer Parameters

The P700 sequencer parameters are listed herein. Refer to section 4.5.7 for P56x Sequencer Diagnostic Parameters.

Code		Possible Settings		IMPORTANT
No.	Name	Default	Selection	
P700	Sequencer Mode	0	0 Disabled 1 Enabled: transition on timer only 2 Enabled: transition on rising edge (P121, 122, 123 = 25 step sequence) 3 Enabled: transition on timer or rising edge	If P700 = 0 and no reference (P121, P101) points to any of the sequence segments, then P701-P799 will not be displayed on the local keypad.
P701	Sequencer: TB13A Trigger Segment	1	1 - 16 TB13A = lowest priority	Asserting TB13A with selection #24 (Start Sequence), starts the sequence operation from the segment specified in this parameter.
P702	Sequencer: TB13B Trigger Segment	1	1 - 16 TB13B: higher priority than TB13A	Asserting TB13B with selection #24 (Start Sequence), starts the sequence operation from the segment specified in this parameter.
P703	Sequencer: TB13C Trigger Segment	1	1 - 16 TB13C: higher priority than TB13B, A	Asserting TB13C with selection #24 (Start Sequence), starts the sequence operation from the segment specified in this parameter.
P704 ⁽²⁾	Sequencer: TB13D Trigger Segment	1	1 - 16 TB13D: higher priority than TB13C, B, A	Asserting TB13D with selection #24 (Start Sequence), starts the sequence operation from the segment specified in this parameter.

(2) Parameter applicable to models 15HP (11kW) and higher.

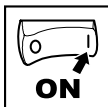

Commissioning

Code		Possible Settings				IMPORTANT
No.	Name	Default	Selection			
P706	Sequencer: Action after Stop/Start transition or Fault Restart	0	0	Restart at beginning of sequence		Pointed by TB13x
			1	Restart at beginning of current seg		
			2	Start at beginning of prior segment		
			3	Start at beginning of next segment		
P707	Sequencer: Number of cycles	1	1	65535		1 = single scan; 65535 = continuous loop
P708	Sequencer: Time units/scaling	0	0	0.1 {sec}	6553.5	Setup units/scaling for all sequencer time related parameters
			1	1 {sec}	65535	
			2	1 {min}	65535	
			NOTE: P708 rescales the following sequencer related parameters: - Segment Times in current step: P712, P717, P722, P727, P732, P737, P742, P747, P752, P757, P762, P767, P772, P777, P782, P787, P792 - Sequence diagnostic/status: P561, P562			
Segment #1						
P710	Segment #1 Frequency Setpoint	0.0	-500.0	{Hz}	500.0	If P112 = 1, negative sign forces reverse direction
P711	Segment #1 Accel/Decel Time	20.0	0.0	{sec}	3600.0	
P712	Segment #1 Time in current step	0.0	0.0	{P708}	6553.5	Scaling/units depend on P708 Skip segment if time = 0
			0	{P708}	65535	
P713	Segment #1 Digital Output State	0	Bit0	Relay		bit = 0: OFF (De-energized) bit = 1: ON (Energized) The corresponding digital output/ relay must be set to accept value the from the sequencer: P140, P142=27
			Bit1	TB14		
P714	Segment #1 TB30 Analog Output Value	0.00	0.00	{VDC}	10.00	TB30 configuration parameter must be set to accept this value: P150 = 10
Segment #2						
P715	Segment #2 Frequency Setpoint	0.0	-500.0	{Hz}	500.0	If P112 = 1, negative sign forces reverse direction
P716	Segment #2 Accel/Decel Time	20.0	0.0	{sec}	3600.0	
P717	Segment #2 Time in current step	0.0	0.0	{P708}	6553.5	Scaling/units depend on P708 Skip segment if time = 0
			0	{P708}	65535	

Commissioning

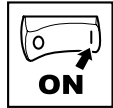

Code		Possible Settings				IMPORTANT
No.	Name	Default	Selection			
P718	Segment #2 Digital Output State	0	Bit0 Relay			bit = 0: OFF (De-energized) bit = 1: ON (Energized) The corresponding digital output/ relay must be set to accept value the from the sequencer: P140, P142=27
			Bit1 TB14			
P719	Segment #2 TB30 Analog Output Value	0.00	0.00	{VDC}	10.00	TB30 configuration parameter must be set to accept this value: P150 = 10
Segment #3						
P720	Segment #3 Frequency Setpoint	0.0	-500.0	{Hz}	500.0	If P112 = 1, negative sign forces reverse direction
P721	Segment #3 Accel/Decel Time	20.0	0.0	{sec}	3600.0	
P722	Segment #3 Time in current step	0.0 0	0.0 0	{P708} {P708}	6553.5 65535	Scaling/units depend on P708 Skip segment if time = 0
P723	Segment #3 Digital Output State	0	Bit0 Relay			bit = 0: OFF (De-energized) bit = 1: ON (Energized) The corresponding digital output/ relay must be set to accept value the
			Bit1 TB14			
P724	Segment #3 TB30 Analog Output Value	0.00	0.00	{VDC}	10.00	TB30 configuration parameter must be set to accept this value: P150 = 10
Segment #4						
P725	Segment #4 Frequency Setpoint	0.0	-500.0	{Hz}	500.0	If P112 = 1, negative sign forces reverse direction
P726	Segment #4 Accel/Decel Time	20.0	0.0	{sec}	3600.0	
P727	Segment #4 Time in current step	0.0 0	0.0 0	{P708} {P708}	6553.5 65535	Scaling/units depend on P708 Skip segment if time = 0
P728	Segment #4 Digital Output State	0	Bit0 Relay			bit = 0: OFF (De-energized) bit = 1: ON (Energized) The corresponding digital output/ relay must be set to accept value the
			Bit1 TB14			
P729	Segment #4 TB30 Analog Output Value	0.00	0.00	{VDC}	10.00	TB30 configuration parameter must be set to accept this value: P150 = 10



Commissioning

Code		Possible Settings				IMPORTANT
No.	Name	Default	Selection			
Segment #5						
P130	Segment #5 Frequency Setpoint	0.0	-500.0	{Hz}	500.0	If P112 = 1, negative sign forces reverse direction
P131	Segment #5 Accel/Decel Time	20.0	0.0	{sec}	3600.0	
P132	Segment #5 Time in current step	0.0 0	0.0 0	{P708} {P708}	6553.5 65535	Scaling/units depend on P708 Skip segment if time = 0
P133	Segment #5 Digital Output State	0	Bit0 Relay Bit1 TB14			bit = 0: OFF (De-energized) bit = 1: ON (Energized) The corresponding digital output/ relay must be set to accept value the from the sequencer: P140, P142=27
P134	Segment #5 TB30 Analog Output Value	0.00	0.00	{VDC}	10.00	TB30 configuration parameter must be set to accept this value: P150 = 10
Segment #6						
P135	Segment #6 Frequency Setpoint	0.0	-500.0	{Hz}	500.0	If P112 = 1, negative sign forces reverse direction
P136	Segment #6 Accel/Decel Time	20.0	0.0	{sec}	3600.0	
P137	Segment #6 Time in current step	0.0 0	0.0 0	{P708} {P708}	6553.5 65535	Scaling/units depend on P708 Skip segment if time = 0
P138	Segment #6 Digital Output State	0	Bit0 Relay Bit1 TB14			bit = 0: OFF (De-energized) bit = 1: ON (Energized) The corresponding digital output/ relay must be set to accept value the from the sequencer: P140, P142=27
P139	Segment #6 TB30 Analog Output Value	0.00	0.00	{VDC}	10.00	TB30 configuration parameter must be set to accept this value: P150 = 10
Segment #7						
P140	Segment #7 Frequency Setpoint	0.0	-500.0	{Hz}	500.0	If P112 = 1, negative sign forces reverse direction
P141	Segment #7 Accel/Decel Time	20.0	0.0	{sec}	3600.0	
P142	Segment #7 Time in current step	0.0 0	0.0 0	{P708} {P708}	6553.5 65535	Scaling/units depend on P708 Skip segment if time = 0

Commissioning

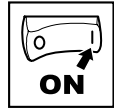

Code		Possible Settings				IMPORTANT
No.	Name	Default	Selection			
P743	Segment #7 Digital Output State	0	Bit0 Relay			bit = 0: OFF (De-energized) bit = 1: ON (Energized) The corresponding digital output/ relay must be set to accept value the
P744	Segment #7 TB30 Analog Output Value	0.00	0.00	{VDC}	10.00	TB30 configuration parameter must be set to accept this value: P150 = 10
Segment #8						
P745	Segment #8 Frequency Setpoint	0.0	-500.0	{Hz}	500.0	If P112 = 1, negative sign forces reverse direction
P746	Segment #8 Accel/Decel Time	20.0	0.0	{sec}	3600.0	
P747	Segment #8 Time in current step	0.0 0	0.0 0	{P708} {P708}	6553.5 65535	Scaling/units depend on P708 Skip segment if time = 0
P748	Segment #8 Digital Output State	0	Bit0 Relay			bit = 0: OFF (De-energized) bit = 1: ON (Energized) The corresponding digital output/ relay must be set to accept value the
P749	Segment #8 TB30 Analog Output Value	0.00	0.00	{VDC}	10.00	TB30 configuration parameter must be set to accept this value: P150 = 10
Segment #9						
P750	Segment #9 Frequency Setpoint	0.0	-500.0	{Hz}	500.0	If P112 = 1, negative sign forces reverse direction
P751	Segment #9 Accel/Decel Time	20.0	0.0	{sec}	3600.0	
P752	Segment #9 Time in current step	0.0 0	0.0 0	{P708} {P708}	6553.5 65535	Scaling/units depend on P708 Skip segment if time = 0
P753	Segment #9 Digital Output State	0	Bit0 Relay			bit = 0: OFF (De-energized) bit = 1: ON (Energized) The corresponding digital output/ relay must be set to accept value the
P754	Segment #9 TB30 Analog Output Value	0.00	0.00	{VDC}	10.00	TB30 configuration parameter must be set to accept this value: P150 = 10



Commissioning

Code		Possible Settings				IMPORTANT
No.	Name	Default	Selection			
Segment #10						
P155	Segment #10 Frequency Setpoint	0.0	-500.0	{Hz}	500.0	If P112 = 1, negative sign forces reverse direction
P156	Segment #10 Accel/Decel Time	20.0	0.0	{sec}	3600.0	
P157	Segment #10 Time in current step	0.0 0	0.0 0	{P708} {P708}	6553.5 65535	Scaling/units depend on P708 Skip segment if time = 0
P158	Segment #10 Digital Output State	0	Bit0 Relay Bit1 TB14			bit = 0: OFF (De-energized) bit = 1: ON (Energized) The corresponding digital output/ relay must be set to accept value the from the sequencer: P140, P142=27
P159	Segment #10 TB30 Analog Output Value	0.00	0.00	{VDC}	10.00	TB30 configuration parameter must be set to accept this value: P150 = 10
Segment #11						
P160	Segment #11 Frequency Setpoint	0.0	-500.0	{Hz}	500.0	If P112 = 1, negative sign forces reverse direction
P161	Segment #11 Accel/Decel Time	20.0	0.0	{sec}	3600.0	
P162	Segment #11 Time in current step	0.0 0	0.0 0	{P708} {P708}	6553.5 65535	Scaling/units depend on P708 Skip segment if time = 0
P163	Segment #11 Digital Output State	0	Bit0 Relay Bit1 TB14			bit = 0: OFF (De-energized) bit = 1: ON (Energized) The corresponding digital output/ relay must be set to accept value the from the sequencer: P140, P142=27
P164	Segment #11 TB30 Analog Output Value	0.00	0.00	{VDC}	10.00	TB30 configuration parameter must be set to accept this value: P150 = 10
Segment #12						
P165	Segment #12 Frequency Setpoint	0.0	-500.0	{Hz}	500.0	If P112 = 1, negative sign forces reverse direction
P166	Segment #12 Accel/Decel Time	20.0	0.0	{sec}	3600.0	
P167	Segment #12 Time in current step	0.0 0	0.0 0	{P708} {P708}	6553.5 65535	Scaling/units depend on P708 Skip segment if time = 0

Commissioning



Code		Possible Settings				IMPORTANT
No.	Name	Default	Selection			
P168	Segment #12 Digital Output State	0	Bit0 Relay			bit = 0: OFF (De-energized) bit = 1: ON (Energized) The corresponding digital output/ relay must be set to accept value the from the sequencer: P140, P142=27
P169	Segment #12 TB30 Analog Output Value	0.00	0.00	{VDC}	10.00	TB30 configuration parameter must be set to accept this value: P150 = 10
Segment #13						
P170	Segment #13 Frequency Setpoint	0.0	-500.0	{Hz}	500.0	If P112 = 1, negative sign forces reverse direction
P171	Segment #13 Accel/Decel Time	20.0	0.0	{sec}	3600.0	
P172	Segment #13 Time in current step	0.0 0	0.0 0	{P708} {P708}	6553.5 65535	Scaling/units depend on P708 Skip segment if time = 0
P173	Segment #13 Digital Output State	0	Bit0 Relay			bit = 0: OFF (De-energized) bit = 1: ON (Energized) The corresponding digital output/ relay must be set to accept value the from the sequencer: P140, P142=27
P174	Segment #13 TB30 Analog Output Value	0.00	0.00	{VDC}	10.00	TB30 configuration parameter must be set to accept this value: P150 = 10
Segment #14						
P175	Segment #14 Frequency Setpoint	0.0	-500.0	{Hz}	500.0	If P112 = 1, negative sign forces reverse direction
P176	Segment #14 Accel/Decel Time	20.0	0.0	{sec}	3600.0	
P177	Segment #14 Time in current step	0.0 0	0.0 0	{P708} {P708}	6553.5 65535	Scaling/units depend on P708 Skip segment if time = 0
P178	Segment #14 Digital Output State	0	Bit0 Relay			bit = 0: OFF (De-energized) bit = 1: ON (Energized) The corresponding digital output/ relay must be set to accept value the from the sequencer: P140, P142=27
P179	Segment #14 TB30 Analog Output Value	0.00	0.00	{VDC}	10.00	TB30 configuration parameter must be set to accept this value: P150 = 10



Commissioning

Code		Possible Settings				IMPORTANT
No.	Name	Default	Selection			
Segment #15						
P780	Segment #15 Frequency Setpoint	0.0	-500.0	{Hz}	500.0	If P112 = 1, negative sign forces reverse direction
P781	Segment #15 Accel/Decel Time	20.0	0.0	{sec}	3600.0	
P782	Segment #15 Time in current step	0.0 0	0.0 0	{P708} {P708}	6553.5 65535	Scaling/units depend on P708 Skip segment if time = 0
P783	Segment #15 Digital Output State	0	Bit0 Relay Bit1 TB14			bit = 0: OFF (De-energized) bit = 1: ON (Energized) The corresponding digital output/ relay must be set to accept value the from the sequencer: P140, P142=27
P784	Segment #15 TB30 Analog Output Value	0.00	0.00	{VDC}	10.00	TB30 configuration parameter must be set to accept this value: P150 = 10
Segment #16						
P785	Segment #16 Frequency Setpoint	0.0	-500.0	{Hz}	500.0	If P112 = 1, negative sign forces reverse direction
P786	Segment #16 Accel/Decel Time	20.0	0.0	{sec}	3600.0	
P787	Segment #16 Time in current step	0.0 0	0.0 0	{P708} {P708}	6553.5 65535	Scaling/units depend on P708 Skip segment if time = 0
P788	Segment #16 Digital Output State	0	Bit0 Relay Bit1 TB14			bit = 0: OFF (De-energized) bit = 1: ON (Energized) The corresponding digital output/ relay must be set to accept value the from the sequencer: P140, P142=27
P789	Segment #16 TB30 Analog Output Value	0.00	0.00	{VDC}	10.00	TB30 configuration parameter must be set to accept this value: P150 = 10
End Segment						
P790	End Segment: Frequency Setpoint	0.0	-500.0	{Hz}	500.0	If P112 = 1, negative sign forces reverse direction
P791	End Segment: Accel/Decel Time	5.0	0.0	{sec}	3600.0	
P792	End Segment: Delay before P793, 794 & 795 activation		0.0 0	{P708} {P708}	6553.5 65535	Scaling/units depend on P708

Commissioning



Code		Possible Settings			IMPORTANT
No.	Name	Default	Selection		
P793	End Segment: Digital Output State		Bit0 Relay		bit = 0: OFF (De-energized) bit = 1: ON (Energized) The corresponding digital output/ relay must be set to accept value the from the sequencer: P140, P142=27
			Bit1 TB14		
P794	End Segment: TB30 Analog Output Value	0.00	0.00	{VDC} 10.00	TB30 configuration parameter must be set to accept this value: P150 = 10
P795	End Segment: Drive Action	0	0 Keep Running		Recovery: Toggling the START SEQUENCE will start the cycle from 'end segment Stop' or 'end segment DC Brake'.
			1 Stop (based on P111)		
2 Coast to Stop					
3 Quick Stop					
4 Coast with DC Brake					
5 Ramp with DC Brake					
			WARNING! If P795 = 0 then toggling the start sequence input will also restart the sequencer cycle but in the interim where TB13X is open the drive will ramp to the standard or specified alternate speed source depending on the drive configuration.		



WARNING

If the input defined to "Start Sequence" is opened during a sequence, the drive will exit sequencer mode and will run at the specified standard or alternate speed source (dependent on drive configuration).

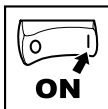

Commissioning

4.5.9.1 Sequencer Parameters

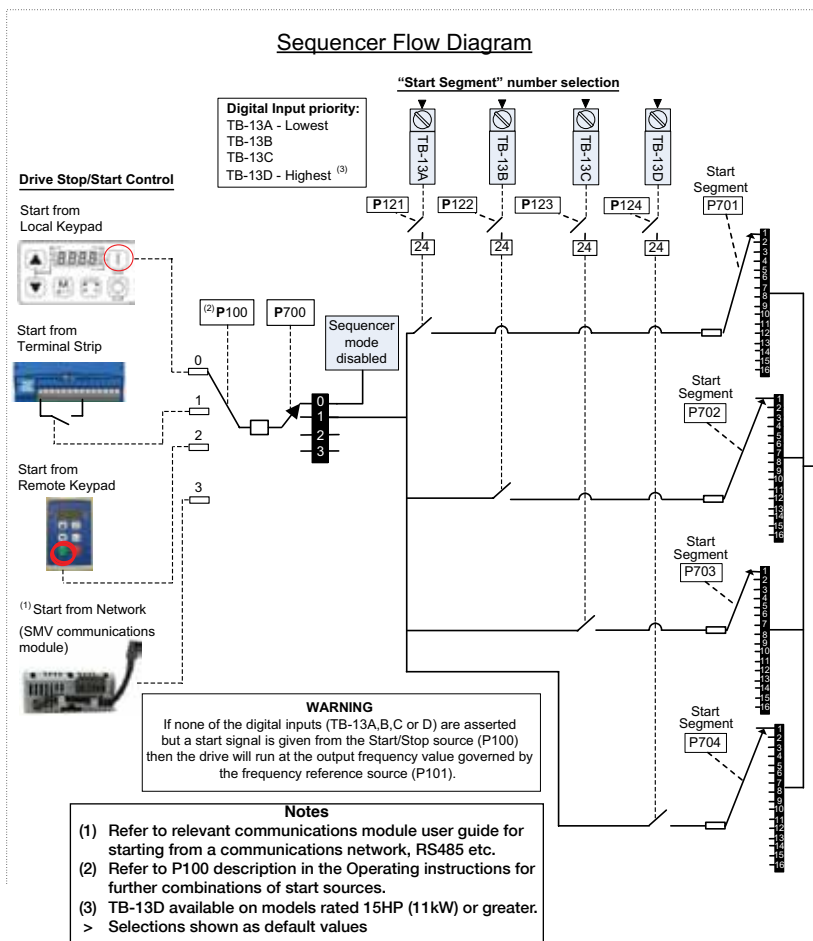

WARNING

If the input defined to "Start Sequence" is opened during a sequence, the drive will exit sequencer mode and will run at the specified standard or alternate speed source (dependent on drive configuration).



4.5.9.2 Sequencer Parameters

Action after Stop/Start (P100) transition/digital input (if setup for sequencer mode) transition or restart after trip.

P706	Action
0	Restart at beginning of sequence (pointed by TB13x)
1	Restart at beginning of current segment
2	Start at beginning of prior segment
3	Start at beginning of next segment

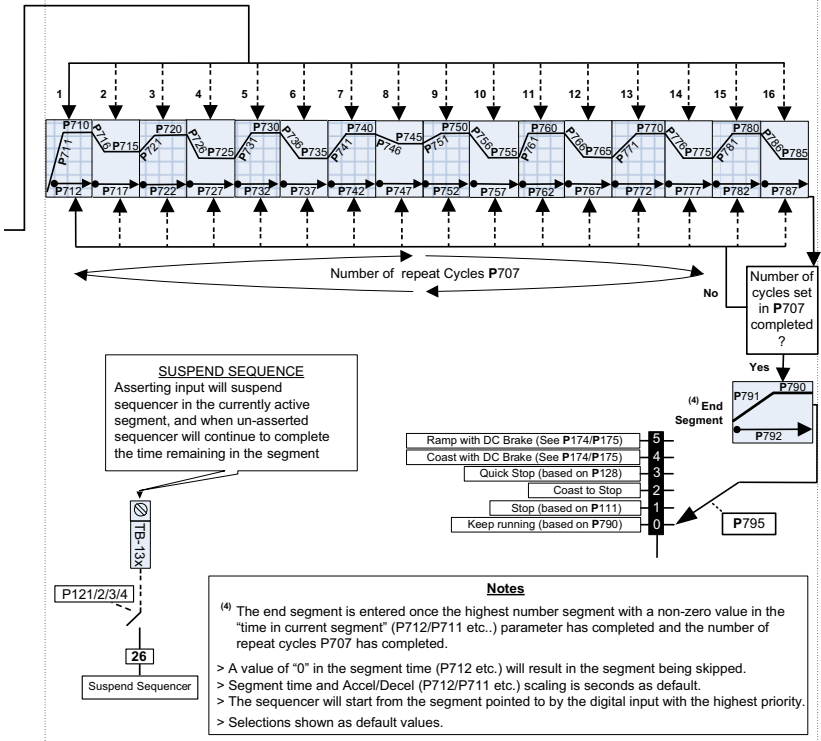

Notes

(4) The end segment is entered once the highest number segment with a non-zero value in the "time in current segment" (P712/P711 etc..) parameter has completed and the number of repeat cycles P707 has completed.

- > A value of "0" in the segment time (P712 etc.) will result in the segment being skipped.
- > Segment time and Accel/Decel (P712/P711 etc.) scaling is seconds as default.
- > The sequencer will start from the segment pointed to by the digital input with the highest priority.
- > Selections shown as default values.



Commissioning

4.5.9.3 Sequencer Status

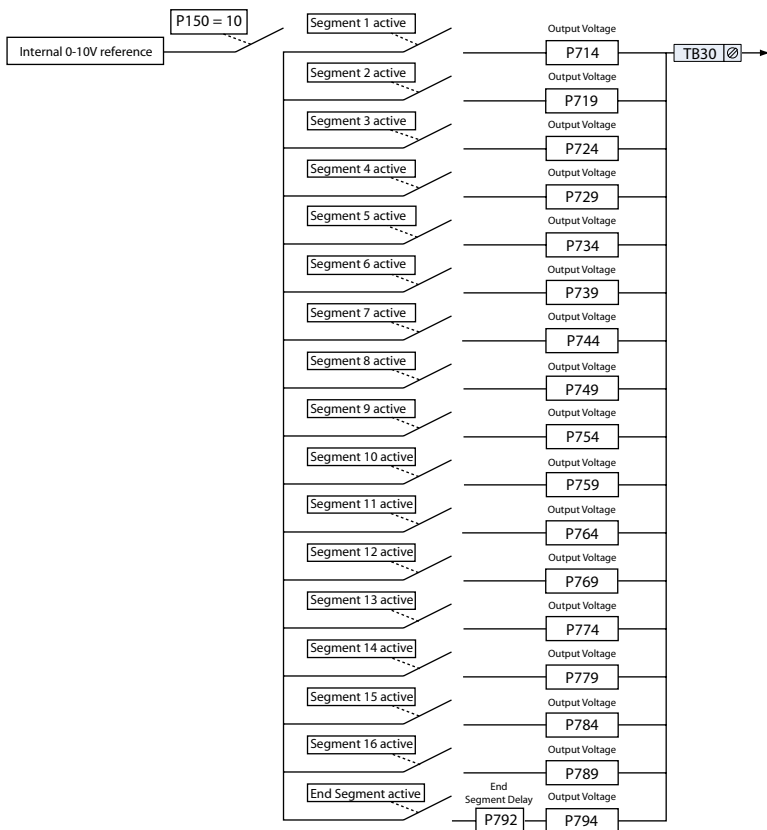

NOTE

On the "End Segment", the output voltage is not present until after the end segment delay P792 has expired. On the other segments the output voltage is present on entry to the segment. The same is true for the digital outputs.



5 Troubleshooting and Diagnostics

5.1 Status/Warning Messages

	Status / Warning	Cause	Remedy
br	DC-injection brake active	DC-injection brake activated <ul style="list-style-type: none"> • activation of digital input (P121...P123 = 18) • automatically (P110 = 2, 4...6) • automatically (P111 = 1, 3) 	Deactivate DC-injection brake <ul style="list-style-type: none"> • deactivate digital input • automatically after P175 time has expired
bF	Drive ID warning	The Drive ID (P502) stored on the EPM does not match the drive model.	<ul style="list-style-type: none"> • Verify motor data (P302...P306) and perform Auto Calibration. • Set drive mode (P300) to 0 or 1 • Reset the drive (P199 to 3 or 4) and reprogram.
CL	Motor Auto-calibration is being performed	See P300, P399	
cE	An EPM that contains valid data from a previous software version has been installed	An attempt was made to change parameter settings	Parameter settings can only be changed after the EPM data is converted to the current version (P199 = 5)
CL	Current Limit (P171) reached	Motor overload	<ul style="list-style-type: none"> • Increase P171 • Verify drive/motor are proper size for application
dEC	Decel Override	The drive has stopped decelerating to avoid tripping into HF fault, due to excessive motor regen (2 sec max).	If drive trips into HF fault: <ul style="list-style-type: none"> • Increase P105, P126 • Install Dynamic Braking option
Err	Error	Invalid data was entered, or an invalid command was attempted	
FCL	Fast Current Limit	Overload	Verify drive/motor are proper size for application
FSt	Flying Restart Attempt after Fault	P110 = 5,6	
GE	OEM Settings Operation warning	An attempt was made to change parameter settings while the drive is operating in OEM Settings mode (P199 = 1)	In OEM Settings mode, making changes to parameters is not permitted
GF	OEM Defaults data warning	An attempt was made to use (or reset to) the OEM default settings (P199 = 1 or 2) using an EPM without valid OEM data.	Install an EPM containing valid OEM Defaults data
LC	Fault Lockout	The drive attempted 5 restarts after a fault but all attempts were unsuccessful (P110 = 3...6)	<ul style="list-style-type: none"> • Drive requires manual reset • Check Fault History (P500) and correct fault condition



Troubleshooting and Diagnostics

Status / Warning		Cause	Remedy
<i>PdEC</i>	PID Deceleration Status	PID setpoint has finished its ramp but the drive is still decelerating to a stop.	
<i>Pl d</i>	PID Mode Active	Drive has been put into PID Mode. See P200.	
<i>SLP</i>	Sleep Mode is active	See P240...P242	
<i>SP</i>	Start Pending	The drive has tripped into a fault and will automatically restart (P110 = 3...6)	To disable Auto-Restart, set P110 = 0...2
<i>SPd</i>	PID Mode disabled.	Drive has been taken out of PID Mode. See P200.	
<i>StoP</i>	Output frequency = 0 Hz (outputs U, V, W inhibited)	Stop has been commanded from the keypad, terminal strip, or network	Apply Start command (Start Control source depends on P100)



5.2 Drive Configuration Messages

When the Mode button is pressed and held, the drive's display will provide a 4-digit code that indicates how the drive is configured. If the drive is in a Stop state when this is done, the display will also indicate which control source commanded the drive to Stop (the two displays will alternate every second).

Configuration Display			
Format = x.y.zz	x = Control Source: L = Local Keypad t = Terminal Strip r = Remote Keypad n = Network	y = Mode: S = Speed mode P = PID mode t = Vector Torque mode	zz = Reference: CP = Keypad ▲ ▼ EU = 0-10 VDC (TB-5) EI = 4-20 mA (TB-25) JG = Jog nt = Network OP = MOP P1...P7 = Preset 1...7 Q1...Q5 = Sequencer Segment
	Example: <ul style="list-style-type: none"> • L.S.CP = Local Keypad Start control, Speed mode, Keypad speed reference • t.P.EU = Terminal Strip Start control, PID mode, 0-10 VDC setpoint reference • t.t.t2 = Terminal Strip Start control, Sequencer Operation (Speed mode), Segment #12 • n.t.P2 = Network Start control, Vector Torque mode, Preset Torque #2 reference • n.S.Q3 = Network Start control, Speed mode, Speed reference from Sequencer Segment #03 		
Stop Source Display			
Format = x.5tP	L.stp = Stop command came from Local Keypad t.stp = Stop command came from Terminal Strip r.stp = Stop command came from Remote Keypad n.stp = Stop command came from Network		



Troubleshooting and Diagnostics

5.3 Fault Messages

The messages below show how they will appear on the display when the drive trips. When looking at the Fault History (P500), the F. will not appear in the fault message.

Fault		Cause	Remedy ⁽¹⁾
F . <i>RF</i>	High Temperature fault	Drive is too hot inside	<ul style="list-style-type: none"> Reduce drive load Improve cooling
F . <i>RL</i>	Assertion Level fault	<ul style="list-style-type: none"> Assertion Level switch is changed during operation P120 is changed during operation P100 or P121...P123 are set to a value other than 0 and P120 does not match the Assertion Level Switch. 	<ul style="list-style-type: none"> Make sure the Assertion Level switch and P120 are both set for the type of input devices being used, prior to setting P100 or P121...P123. See 3.2.3 and P120.
F . <i>bF</i>	Personality fault	Drive Hardware	<ul style="list-style-type: none"> Cycle Power
F . <i>CF</i>	Control fault	An EPM has been installed that is either blank or corrupted	<ul style="list-style-type: none"> Power down and install EPM with valid data
F . <i>cF</i>	Incompatible EPM fault	An EPM has been installed that contains data from an incompatible parameter version	<ul style="list-style-type: none"> Reset the drive back to defaults (P199 = 3, 4) and then re-program If problem persists, contact factory technical support
F . <i>dbF</i>	Dynamic Braking fault	Dynamic braking resistors are overheating	<ul style="list-style-type: none"> Increase active decel time (P105, P126, P127). Check mains voltage and P107
F . <i>EF</i>	External fault	<ul style="list-style-type: none"> P121...P123 = 21 and that digital input has been opened. P121...P123 = 22 and that digital input has been closed. 	<ul style="list-style-type: none"> Correct the external fault condition Make sure digital input is set properly for NC or NO circuit
F . <i>F I</i>	EPM fault	EPM missing or defective	Power down and replace EPM
F . <i>F2</i> ... F . <i>F i2</i>	Internal faults		Contact factory technical support
F . <i>Fnr</i>	Control Configuration Fault	<p>The drive is setup for REMOTE KEYPAD control (P100=2 or 5) but is not setup to communicate with a remote keypad</p> <p>The drive is setup for NETWORK ONLY control (P100=3) but is not setup for network communications</p>	<p>Set P400 = 1, or P600 = 1</p> <p>Set P400 or P600 to a valid network communications protocol selection</p>
F . <i>FaL</i>	Loss of 4-20 mA signal fault	4-20 mA signal (at TB-25) is below 2 mA (P163 = 1)	Check signal/signal wire
F . <i>GF</i>	OEM Defaults data fault	Drive is powered up with P199 = 1 and OEM settings in the EPM are not valid.	Install an EPM containing valid OEM Defaults data or change P199 to 0.

(1) The drive can only be restarted if the error message has been reset.

Troubleshooting and Diagnostics



Fault		Cause	Remedy ⁽¹⁾
F.HF	High DC Bus Voltage fault	Mains voltage is too high	Check mains voltage and P107
		Decel time is too short, or too much regen from motor	Increase active decel time (P105, P126, P127) or install Dynamic Braking option
F.IL	Digital Input Configuration fault (P121...P123)	More than one digital input set for the same function	Each setting can only be used once (except settings 0 and 3)
		Only one digital input configured for MOP function (Up, Down)	One input must be set to MOP Up, another must be set to MOP Down
		PID mode is entered with setpoint reference and feedback source set to the same analog signal	Change PID setpoint reference (P121...P123) or feedback source (P201).
		One of the digital inputs (P121...P123) is set to 10 and another is set to 11...14.	Reconfigure digital inputs
		One of the digital inputs (P121...P123) is set to 11 or 12 and another is set to 13 or 14.	
PID enabled in Vector Torque mode (P200 = 1 or 2 and P300 = 5)	PID cannot be used in Vector Torque mode		
F.JF	Remote keypad fault	Remote keypad disconnected	Check remote keypad connections
F.LF	Low DC Bus Voltage fault	Mains voltage too low	Check mains voltage
F.nId	No Motor ID fault	An attempt was made to start the drive in Vector or Enhanced V/Hz mode prior to performing the Motor Auto-calibration	See P300...P399 for Drive Mode setup and calibration.
F.nEF	Module communication fault	Communication failure between drive and Network Module.	Check module connections
F.nFI ... F.nF9	Network Faults	Refer to the module documentation for Causes and Remedies.	
F.DF	Output fault: Transistor fault	Output short circuit	Check motor/motor cable
		Acceleration time too short	Increase P104, P125
		Severe motor overload, due to: <ul style="list-style-type: none"> • Mechanical problem • Drive/motor too small for application 	<ul style="list-style-type: none"> • Check machine / system • Verify drive/motor are proper size for application
		Boost values too high	Decrease P168, P169
		Excessive capacitive charging current of the motor cable	<ul style="list-style-type: none"> • Use shorter motor cables with lower charging current • Use low capacitance motor cables • Install reactor between motor and drive.
		Failed output transistor	Contact factory technical support

(1) The drive can only be restarted if the error message has been resent.



Troubleshooting and Diagnostics

Fault		Cause	Remedy ⁽¹⁾
F.OF1	Output fault: Ground fault	Grounded motor phase	Check motor and motor cable
		Excessive capacitive charging current of the motor cable	Use shorter motor cables with lower charging current
F.PF	Motor Overload fault	Excessive motor load for too long	<ul style="list-style-type: none">• Verify proper setting of P108• Verify drive and motor are proper size for application
F.rF	Flying Restart fault	Controller was unable to synchronize with the motor during restart attempt; (P110 = 5 or 6)	Check motor / load
F.5F	Single-Phase fault	A mains phase has been lost	Check mains voltage
F.UF	Start fault	Start command was present when power was applied (P110 = 0 or 2).	<ul style="list-style-type: none">• Must wait at least 2 seconds after power-up to apply Start command• Consider alternate starting method (see P110).

(1) The drive can only be restarted if the error message has been reset.



Appendix A

A.1 Permissible Cable Lengths

The table herein lists the permissible cable lengths for use with an SM Flux Vector inverter with an internal EMC filter.



NOTE

This table is intended as a reference guideline only; application results may vary. The values in this table are based on testing with commonly available low-capacitance shielded cable and commonly available AC induction motors. Testing is conducted at worst case speeds and loads.

Maximum Permissible Cable Lengths (Meters) for SM Flux Vector Models with Internal EMC Filters									
Mains	Model	4 kHz Carrier (P166 = 0)		6 kHz Carrier (P166 = 1)		8 kHz Carrier (P166 = 2)		10 kHz Carrier (P166 = 3)	
		Class A	Class B	Class A	Class B	Class A	Class B	Class A	Class B
240 V, 1-phase (2/PE)	ESV251 ^{①②③} 2SF ^④	38	12	35	10	33	5	30	N/A
	ESV371 ^{①②③} 2SF ^④	38	12	35	10	33	5	30	N/A
	ESV751 ^{①②③} 2SF ^④	38	12	35	10	33	5	30	N/A
	ESV112 ^{①②③} 2SF ^④	38	12	35	10	33	5	30	N/A
	ESV152 ^{①②③} 2SF ^④	38	12	35	10	33	5	30	N/A
	ESV222 ^{①②③} 2SF ^④	38	12	35	10	33	5	30	N/A
400/480 V, 3-phase (3/PE)	ESV371 ^{①②③} 4TF ^④	30	4	25	2	20	N/A	10	N/A
	ESV751 ^{①②③} 4TF ^④	30	4	25	2	20	N/A	10	N/A
	ESV112 ^{①②③} 4TF ^④	30	4	25	2	20	N/A	10	N/A
	ESV152 ^{①②③} 4TF ^④	30	4	25	2	20	N/A	10	N/A
	ESV222 ^{①②③} 4TF ^④	30	4	25	2	20	N/A	10	N/A
	ESV302 ^{①②③} 4TF ^④	30	4	25	2	20	N/A	10	N/A
	ESV402 ^{①②③} 4TF ^④	54	5	48	3	42	2	N/A	N/A
	ESV552 ^{①②③} 4TF ^④	54	5	48	3	42	2	N/A	N/A
	ESV752 ^{①②③} 4TF ^④	54	5	48	3	42	2	N/A	N/A

NOTE: The “^{①②③}” and “^④” symbols are place holders in the Model part number that contain different information depending on the specific configuration of the model.



Important Information

Resale of Goods

In the event of the resale of any of the goods, in whatever form, Resellers/Buyers will include the following language in a conspicuous place and in a conspicuous manner in a written agreement covering such sale:

The manufacturer makes no warranty or representations, express or implied, by operation of law or otherwise, as to the merchantability or fitness for a particular purpose of the goods sold hereunder. Buyer acknowledges that it alone has determined that the goods purchased hereunder will suitably meet the requirements of their intended use. In no event will the manufacturer be liable for consequential, incidental or other damages. Even if the repair or replacement remedy shall be deemed to have failed of its essential purpose under Section 2-719 of the Uniform Commercial Code, the manufacturer shall have no liability to Buyer for consequential damages.

Resellers/Buyers agree to also include this entire document including the warnings and cautions above in a conspicuous place and in a conspicuous manner in writing to instruct users on the safe usage of the product.

This information should be read together with all other printed information supplied by LEESON Electric.

For more information contact: **LEESON Electric**, 1051 Cheyenne Avenue, Grafton, Wisconsin 53024
Phone: 262-377-8810 Fax: 262-377-9025.



LEESON Electric
Grafton, Wisconsin 53024 U.S.A.
PH: 262-377-8810
FAX: 262-377-9025

www.leeson.com

REGAL BELOIT CANADA
Mississauga (Toronto), Ontario, Canada L5T 2N7
PH: 905-670-4770
FAX: 905-670-4378
Service Dept. FAX: 262-377-0090

www.lesson.ca

A Regal Brand

REGAL

www.regalbeloit.com